

# Artemide®

## Meteorite 48

design  
Pio & Tito Toso

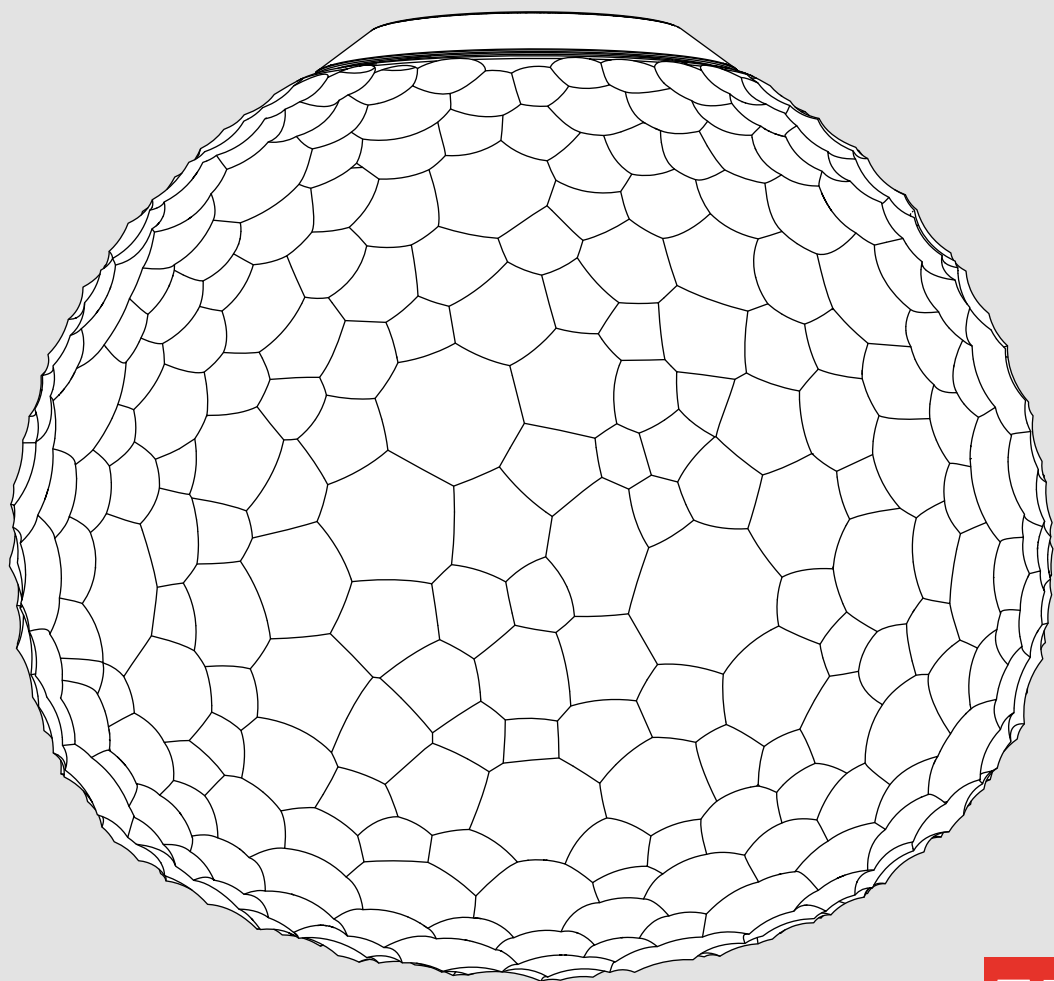



i

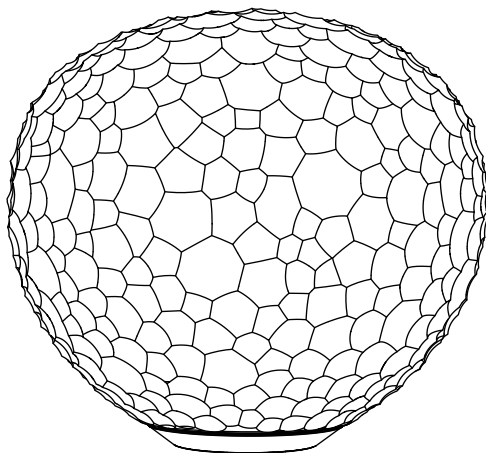
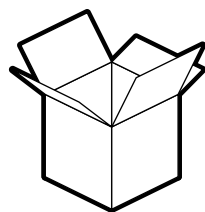
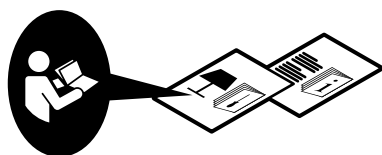
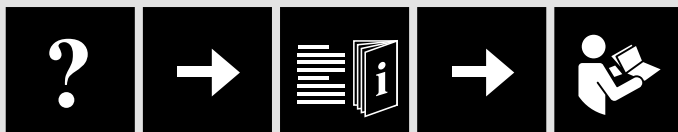
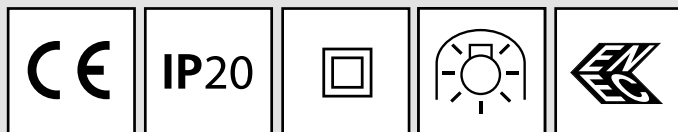

1

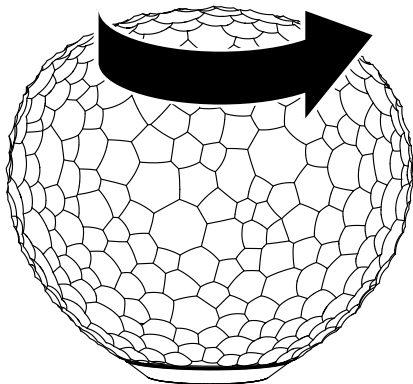

2

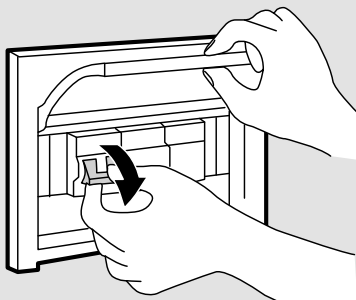
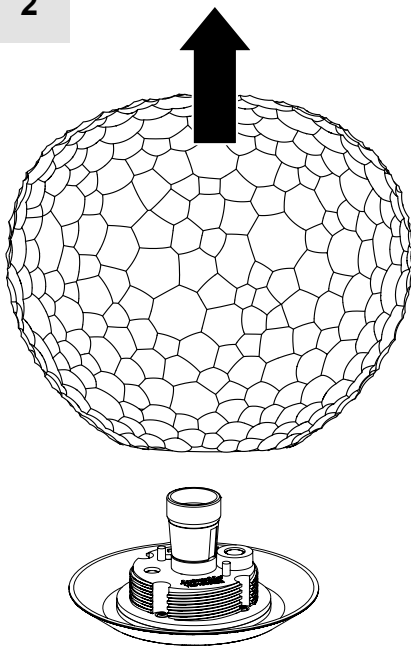

3

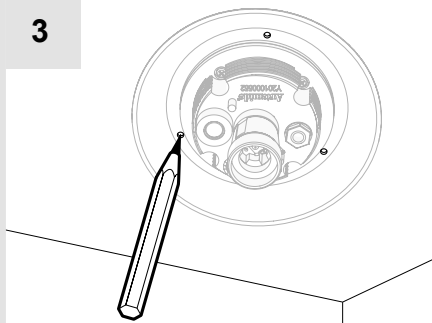

4

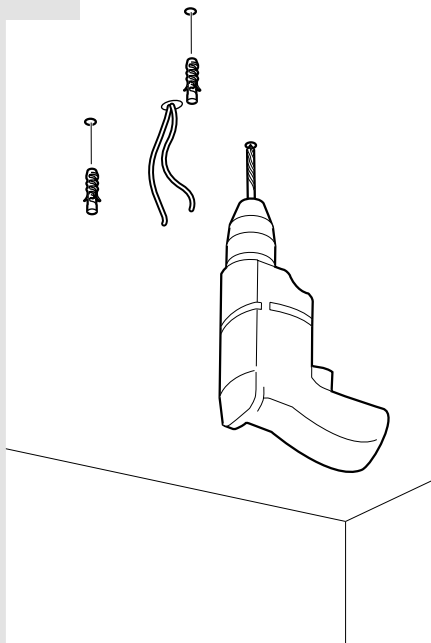

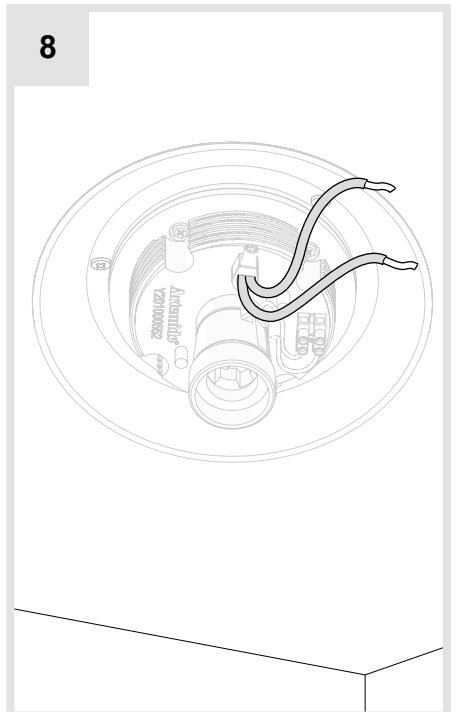
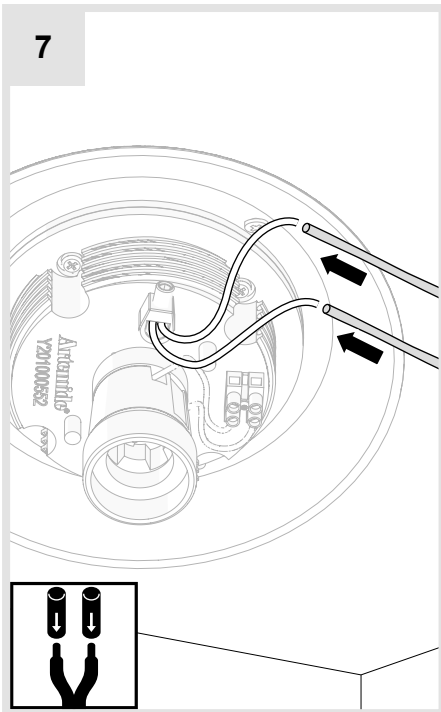
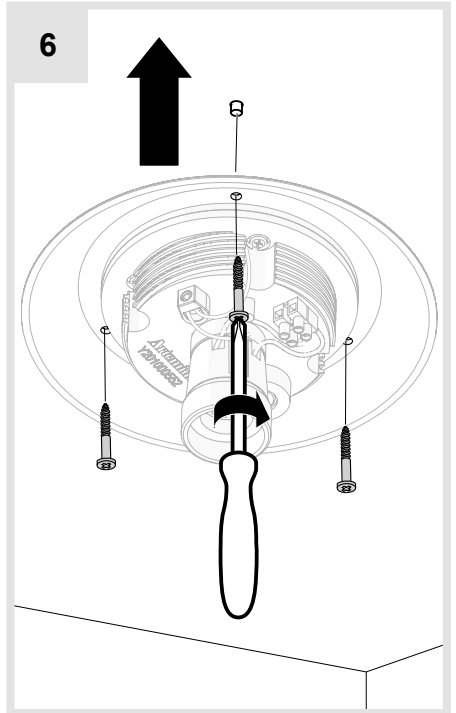
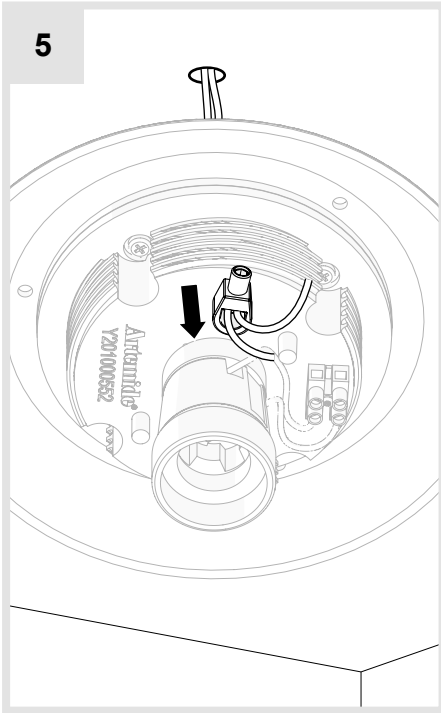

9

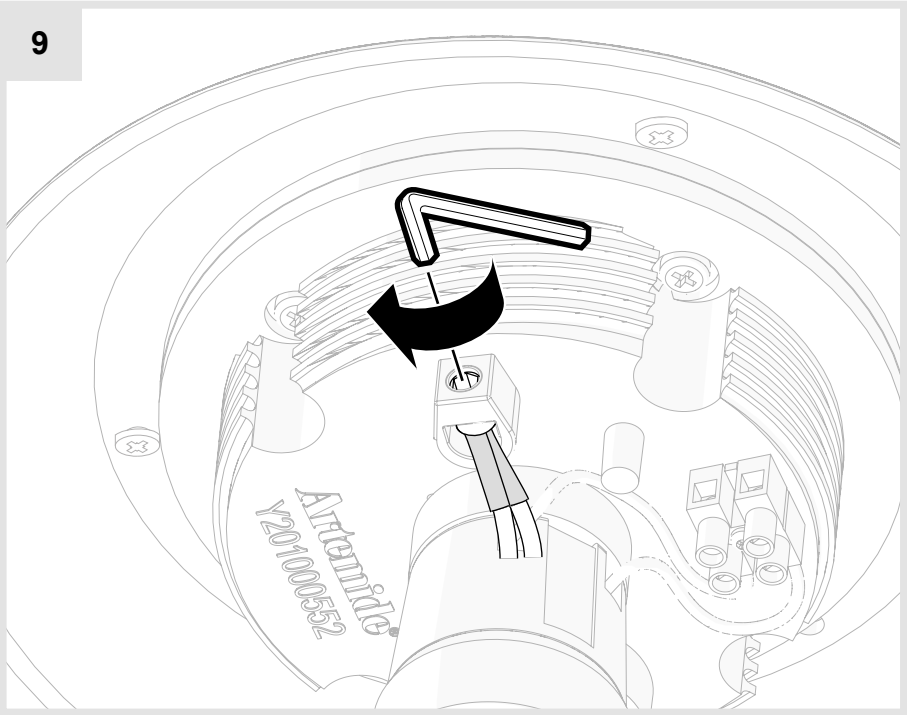

10

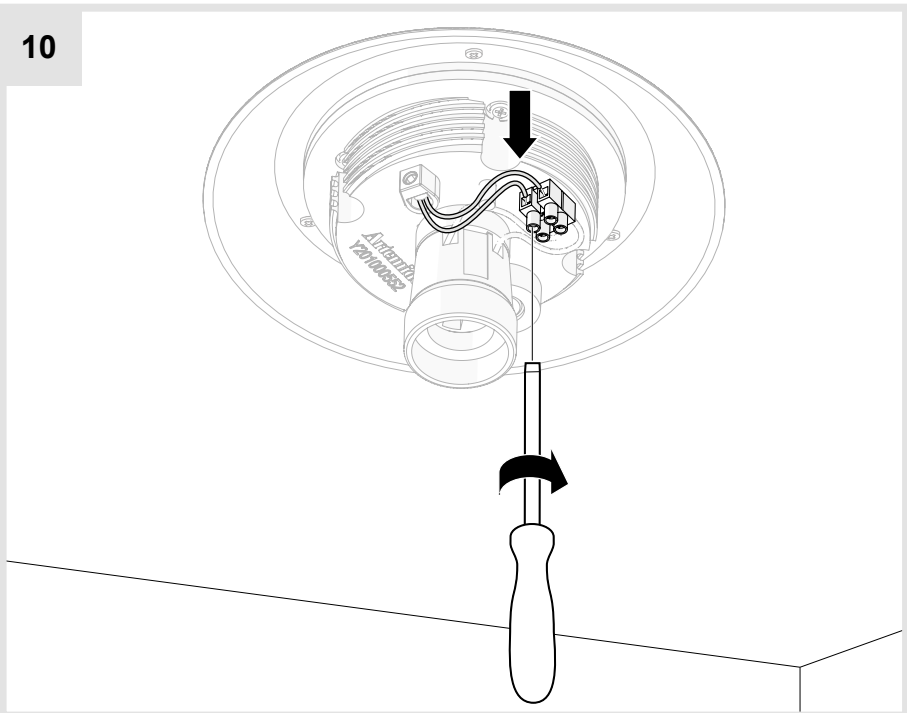

11

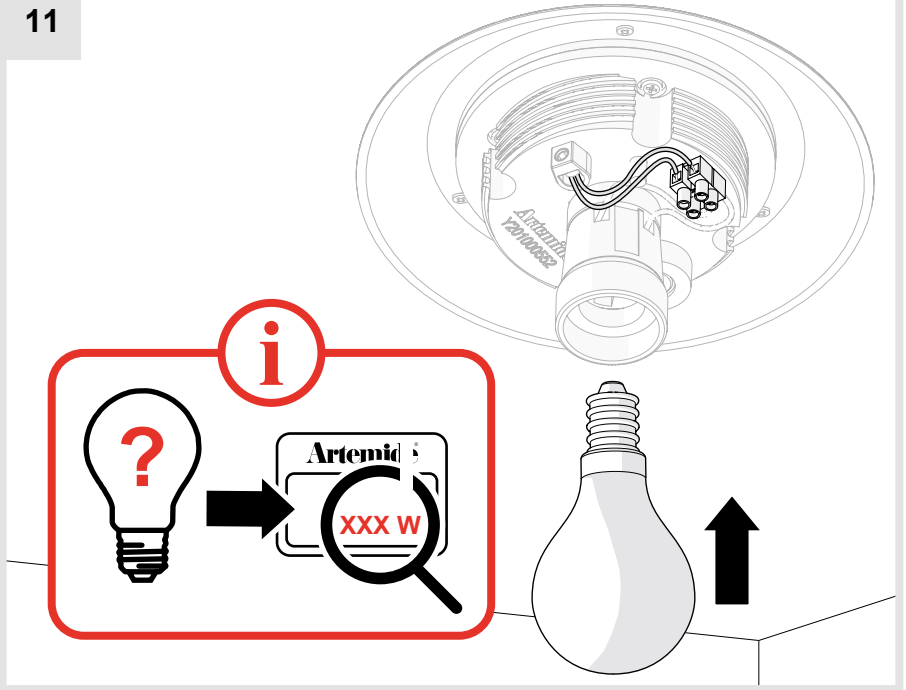

12

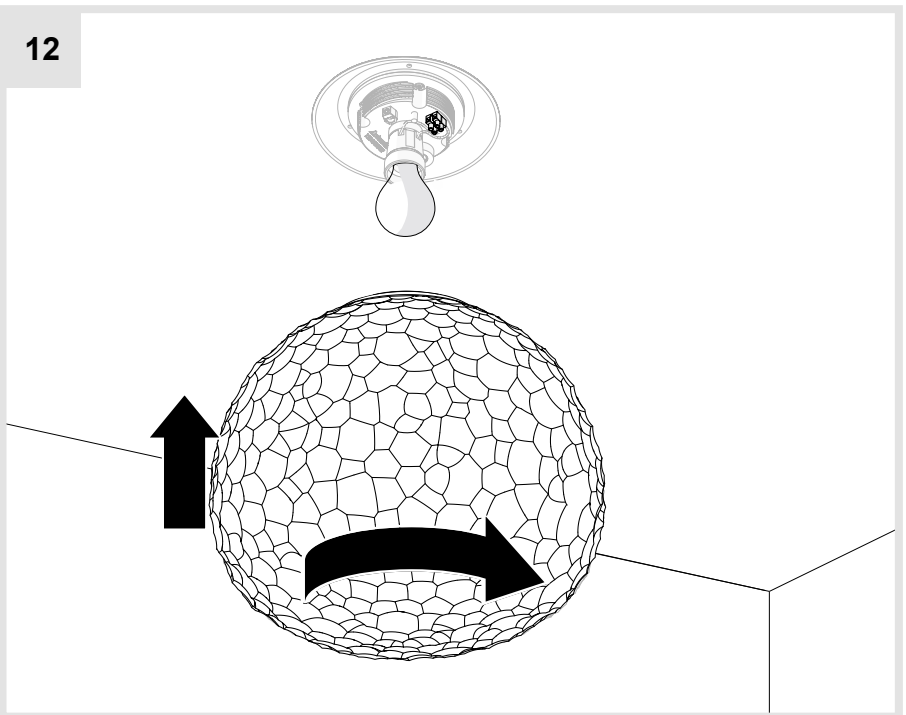

i



1 →

2 →

11 →

12

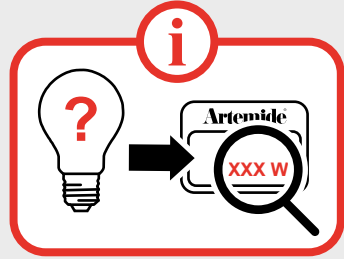
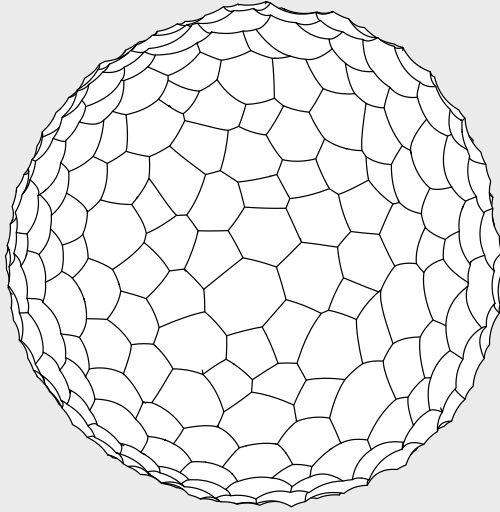

i

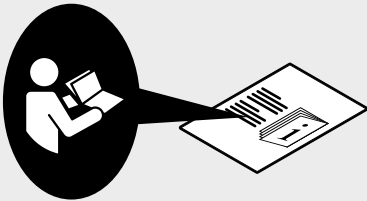

1

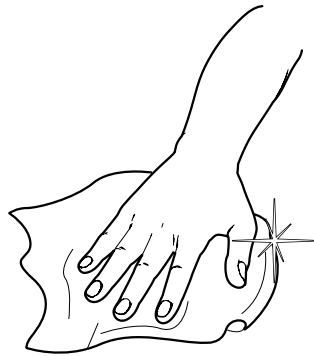

**Artemide®**

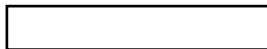

**Artemide**

via Bergamo, 18  
20006 Pregnana M.se (MI)  
ITALIA

tel. +39 02 935 181  
fax +39 02 935 90 254  
fax +39 02 935 90 496

[www.artemide.com](http://www.artemide.com)

VAT IT00846890150

cod. Y513000576B