

# Artemide®

## Meteorite 15

design  
Pio & Tito Toso

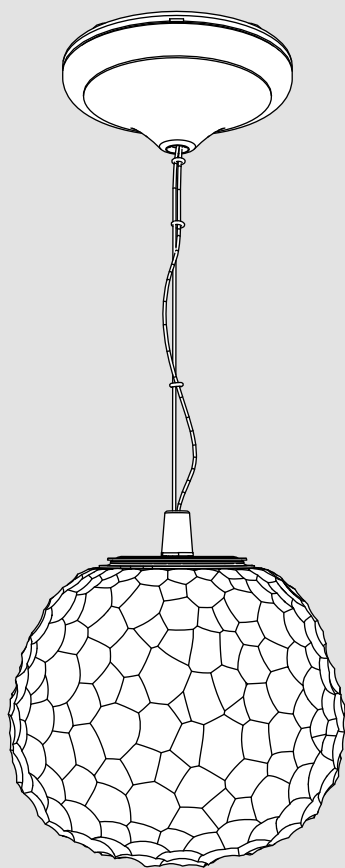



i

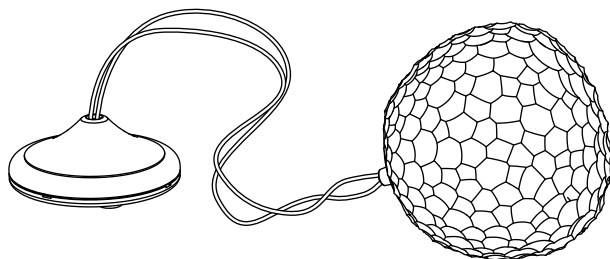
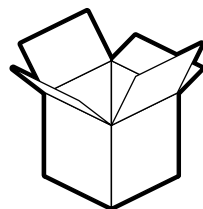
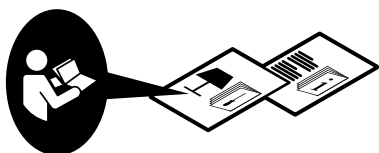

1

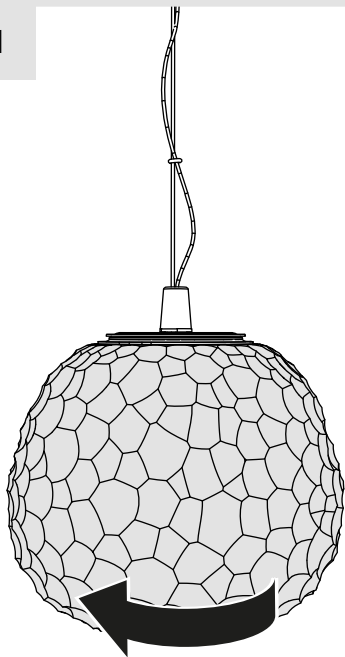

2

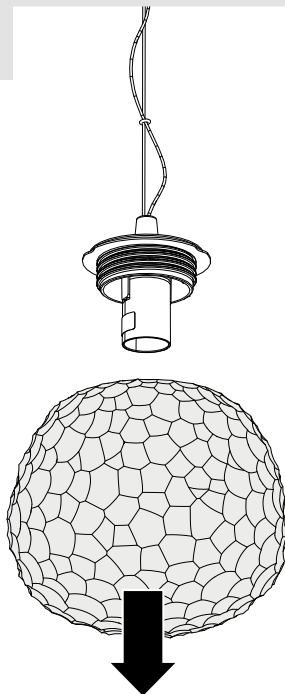

3

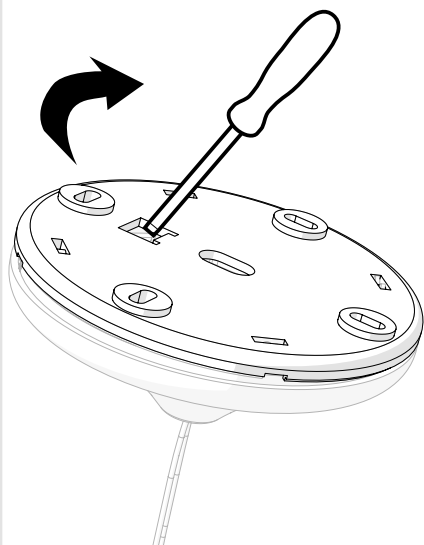

4

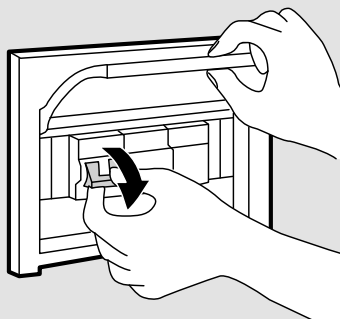
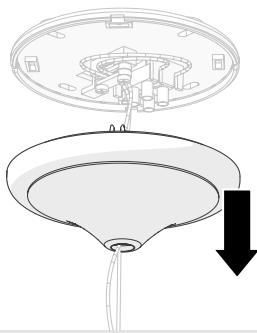

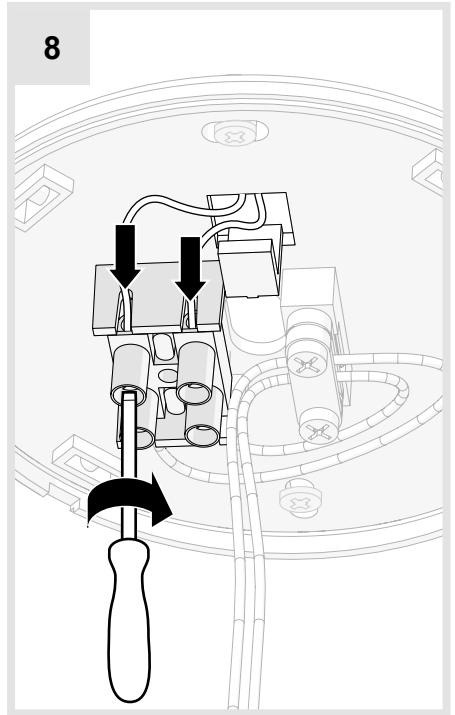
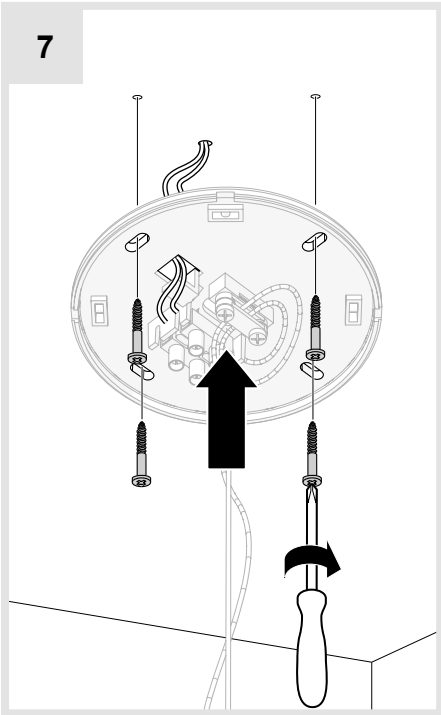
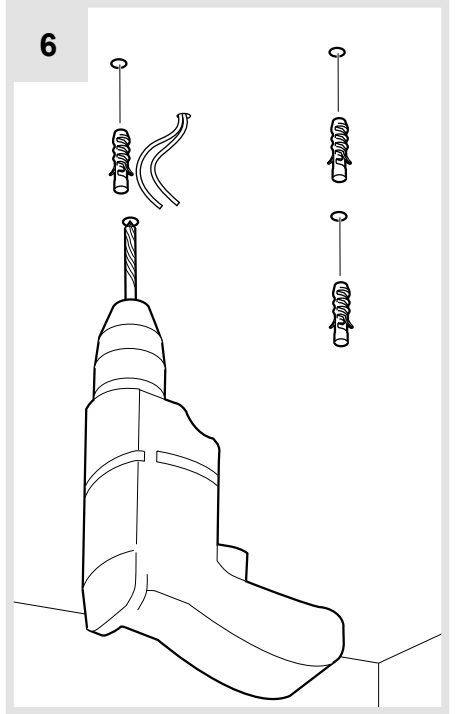
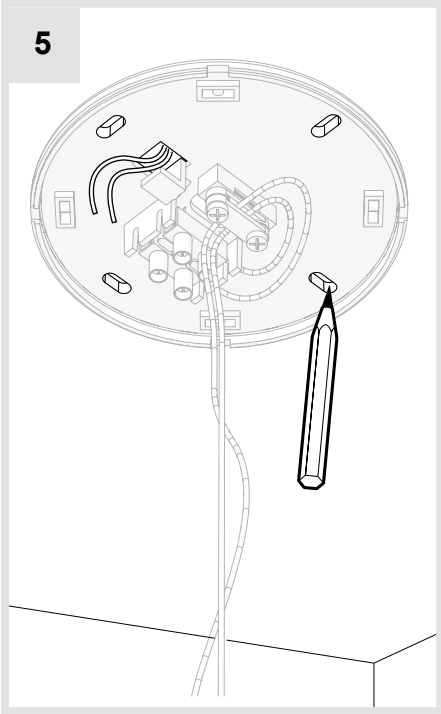

9

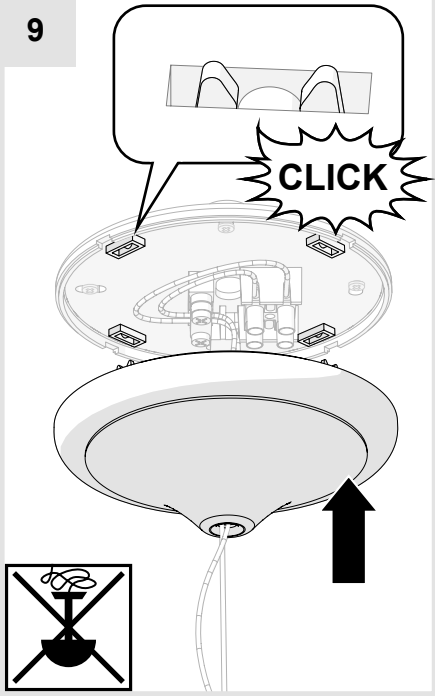

10

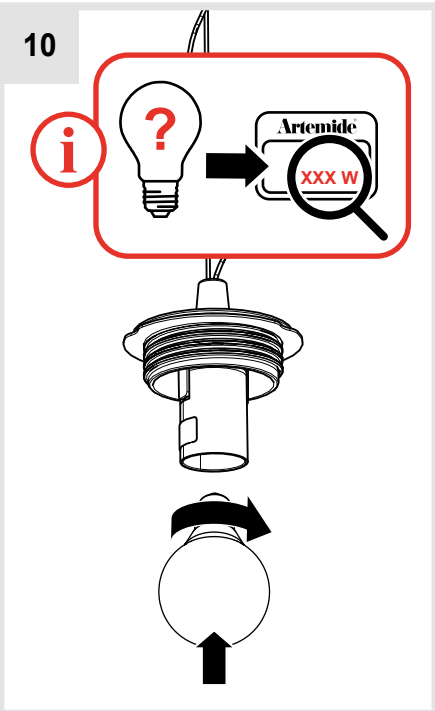

11

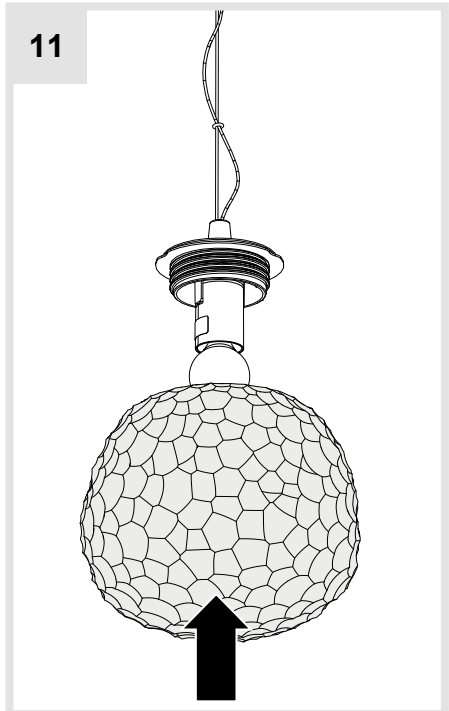

12

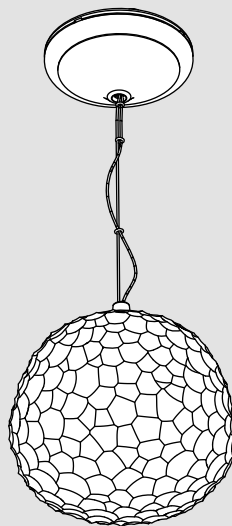
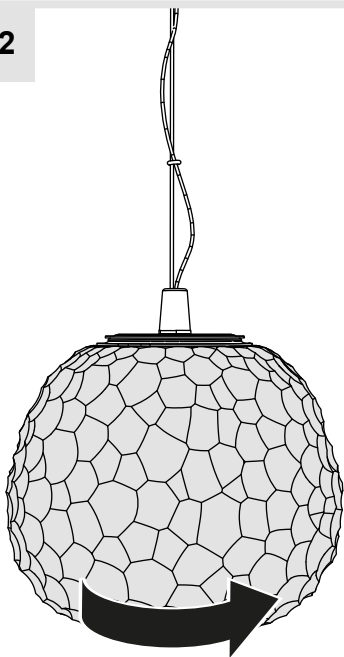

**i**

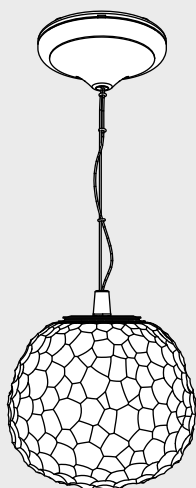
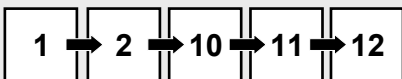

**i**

max 50 mm  
[1" 31/32]

max 80 mm  
[3" 5/32]

Artemide®

XXX W

A red-bordered box containing an information icon (i), a light bulb with a question mark, and a magnifying glass over the text 'Artemide®' and 'XXX W'. Dimension lines indicate a maximum diameter of 50 mm (1" 31/32) and a maximum height of 80 mm (3" 5/32). An arrow points from the bulb to the magnifying glass.

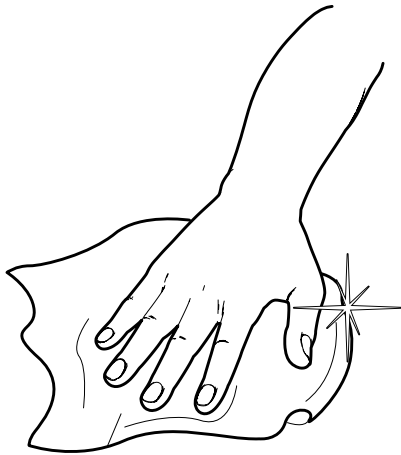
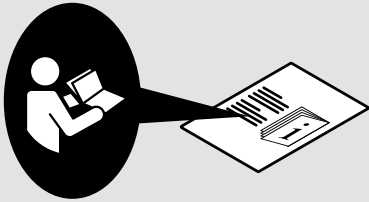

**Artemide®**

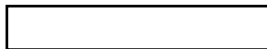

## **Artemide**

via Bergamo, 18  
20006 Pregnana M.se (MI)  
ITALIA

tel. +39 02 935 181  
fax +39 02 935 90 254  
fax +39 02 935 90 496

[www.artemide.com](http://www.artemide.com)

VAT IT00846890150

cod. Y513000998B