

Artemide®

Talo

design
N. Poulton

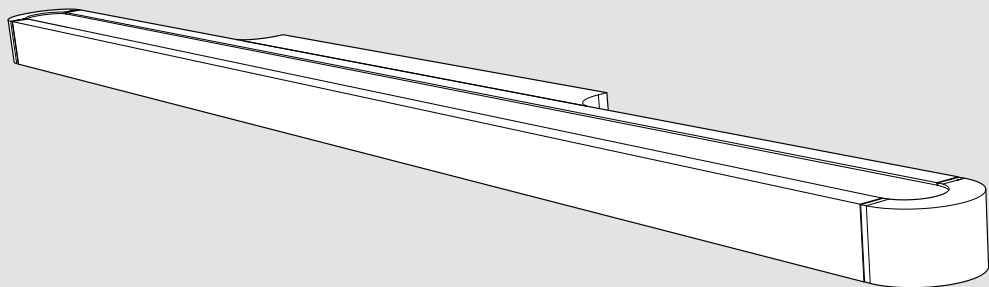



i

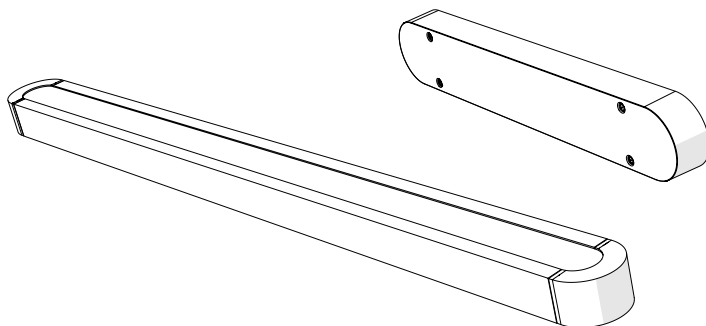
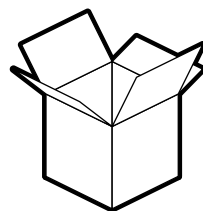
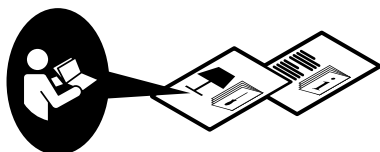
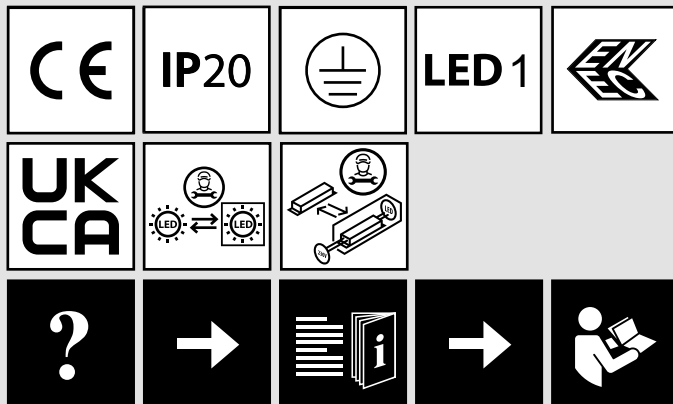

1

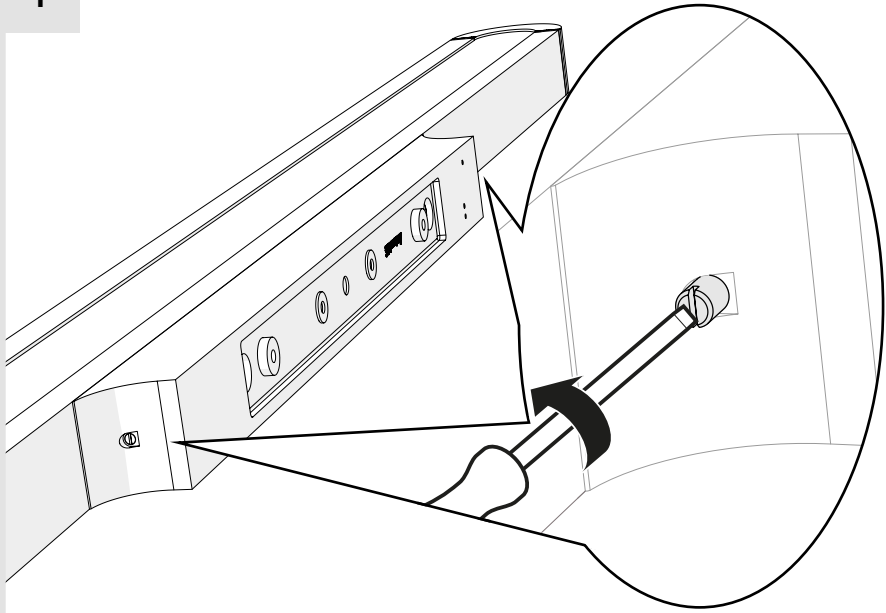

2

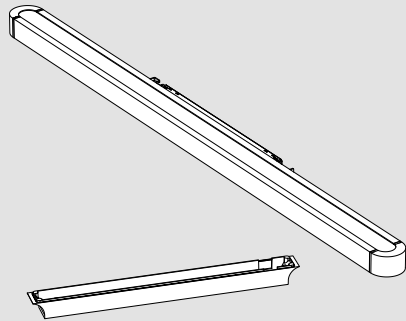
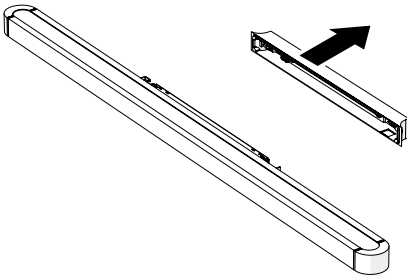

3

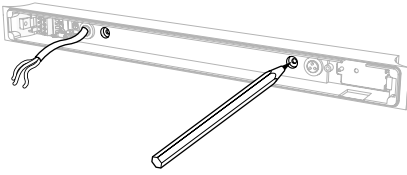

5

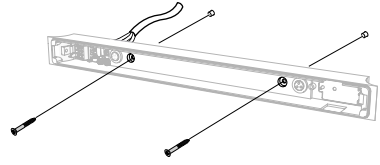

4

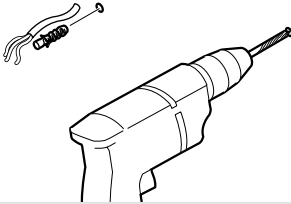

6a

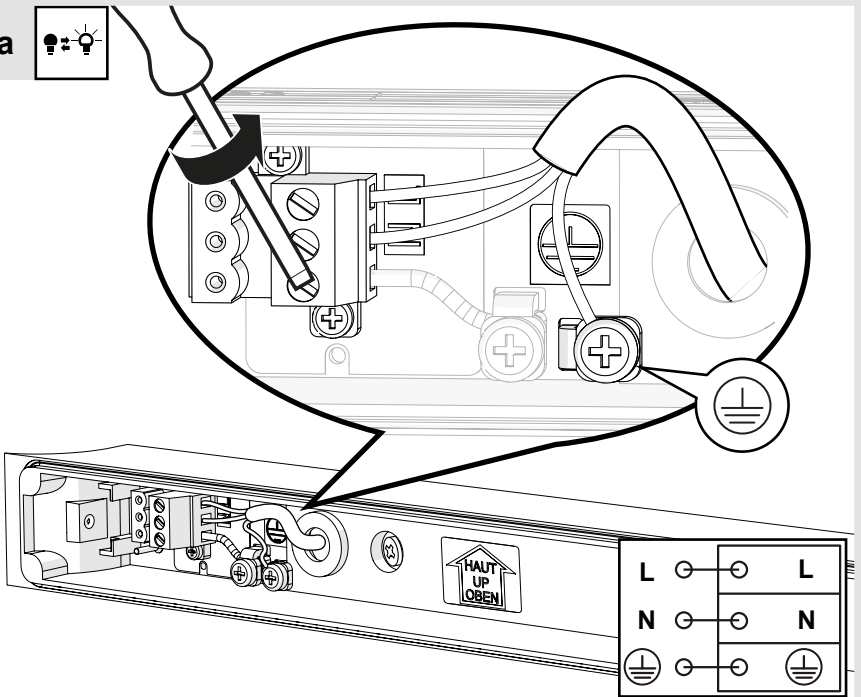

6b

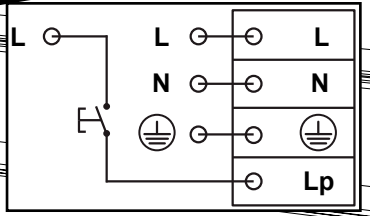
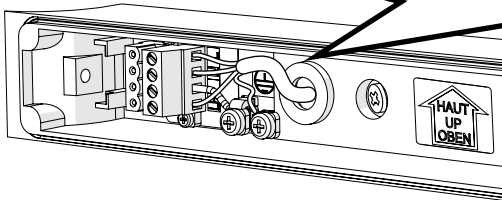
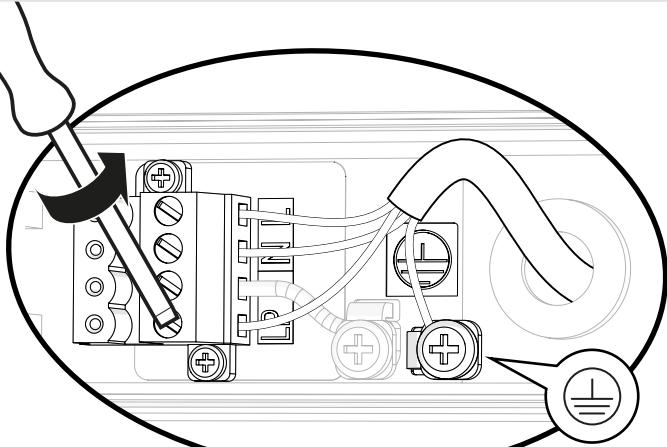

7

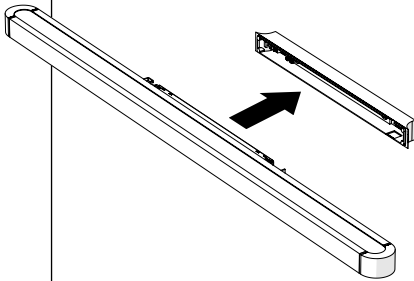

8

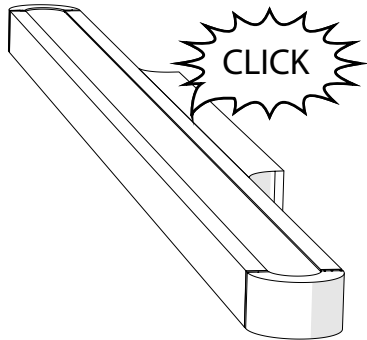

9

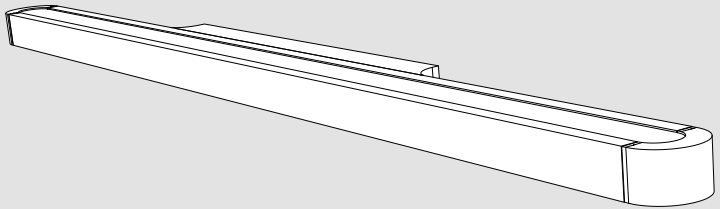
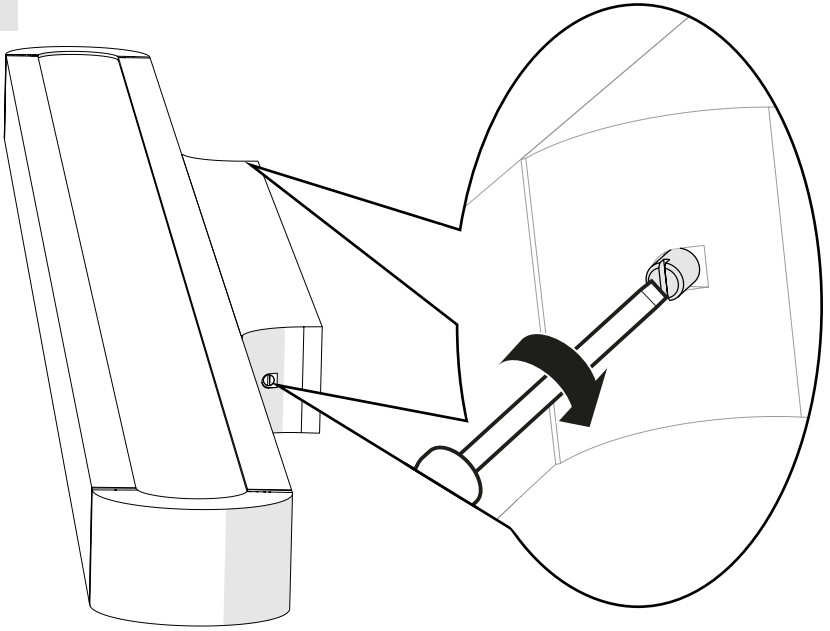

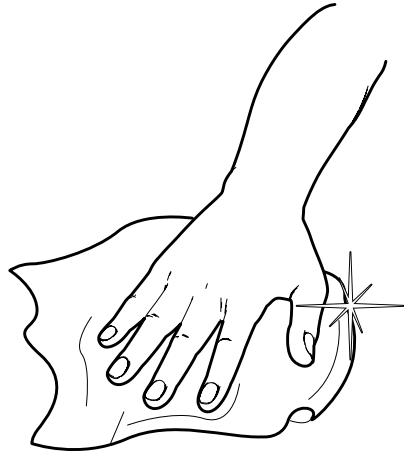
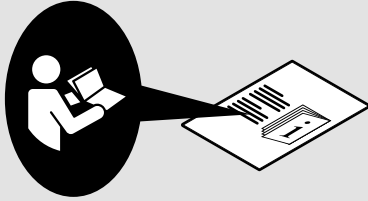

Artemide®

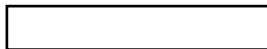

Artemide

via Bergamo, 18
20006 Pregnana M.se (MI)
ITALIA

tel. +39 02 935 181
fax +39 02 935 90 254
fax +39 02 935 90 496

www.artemide.com

VAT IT00846890150

cod. Y513000193E