

# Artemide®

## Cabildo

design  
E. Solè

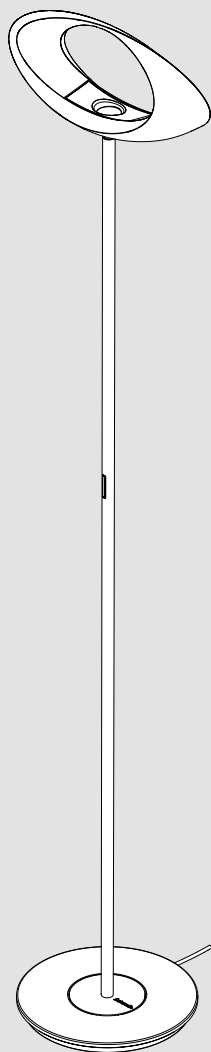



i

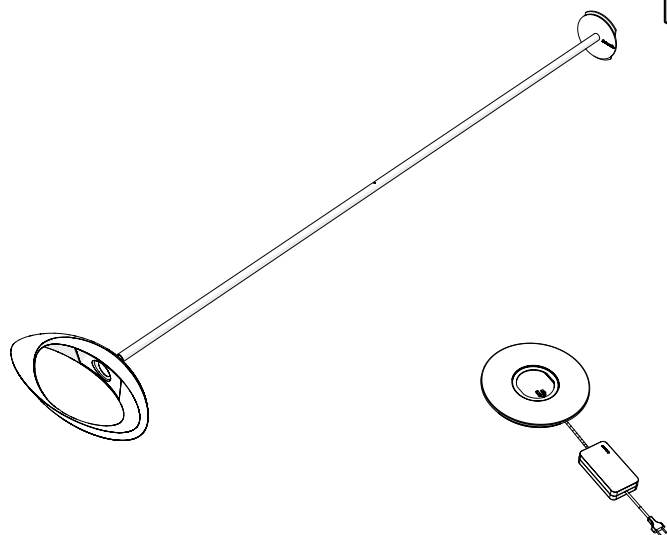
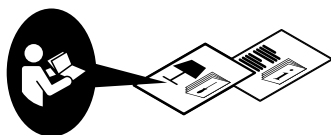
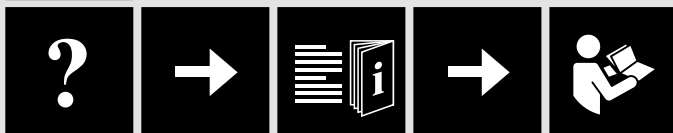
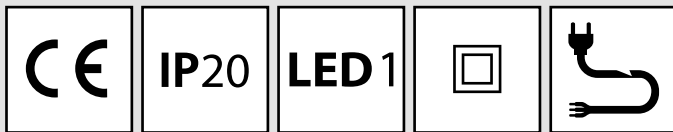

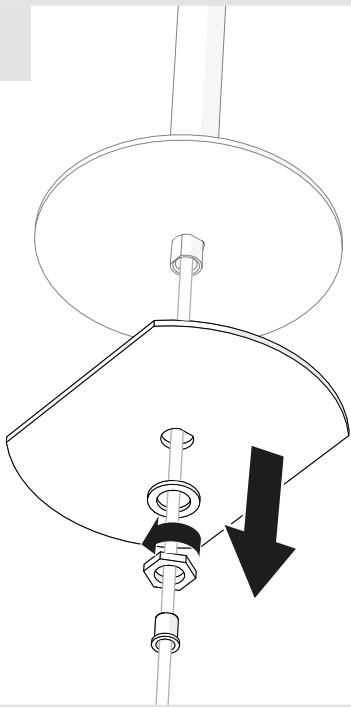
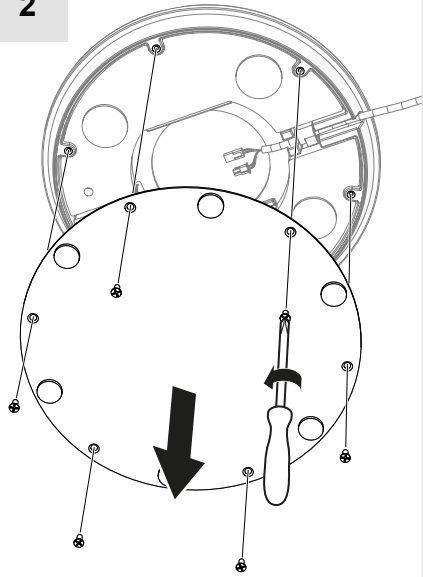
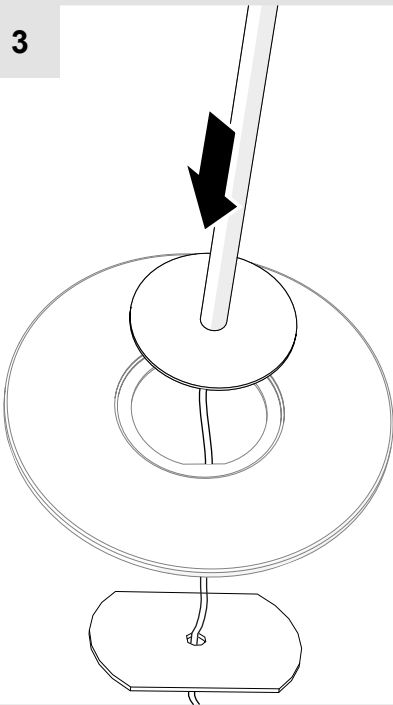
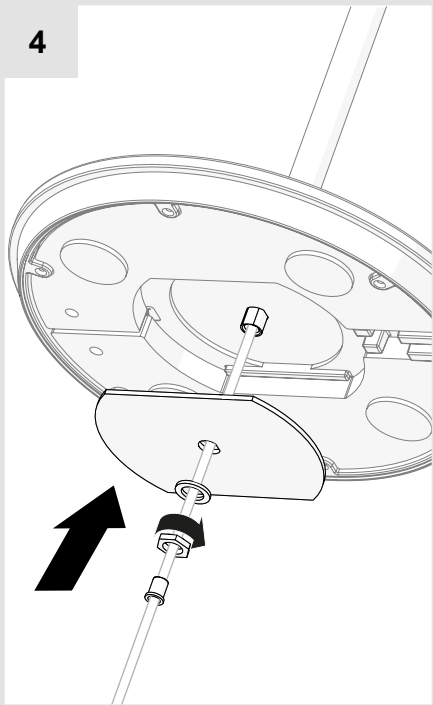
**1****2****3****4**

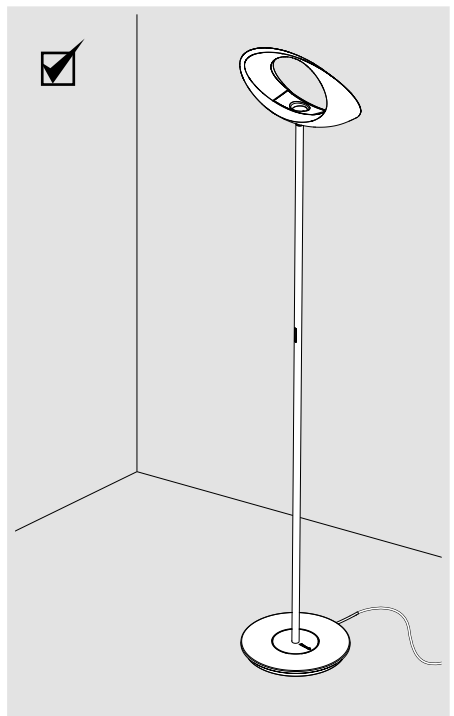
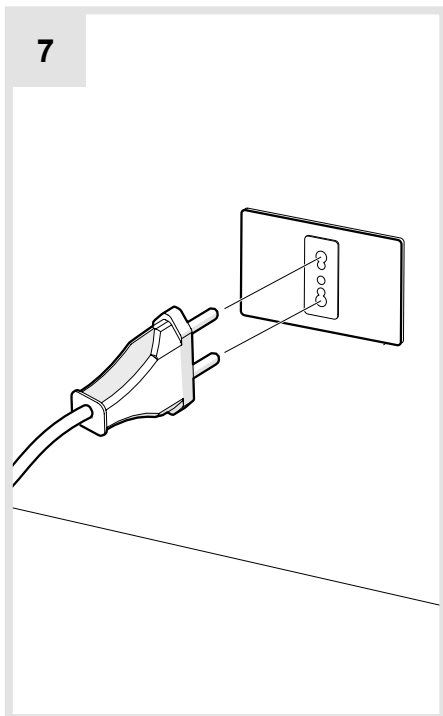
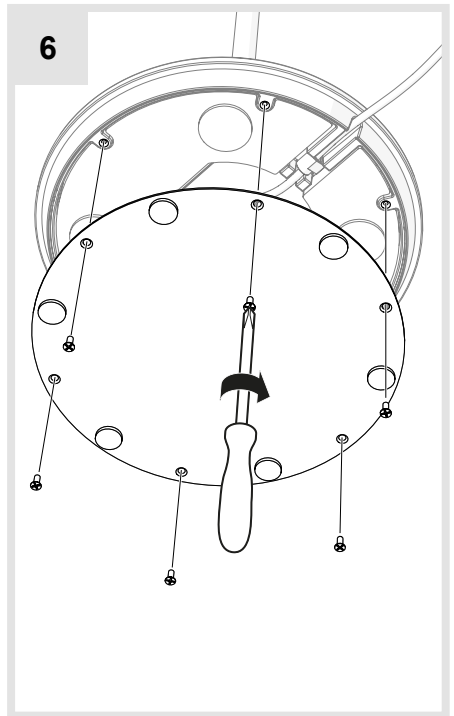
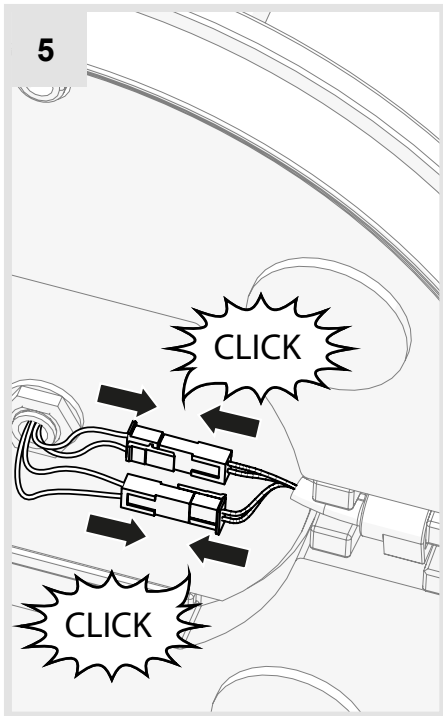



**i**

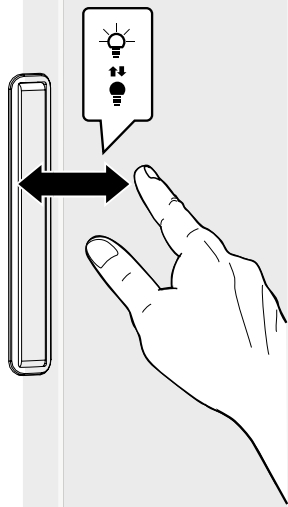

**i**

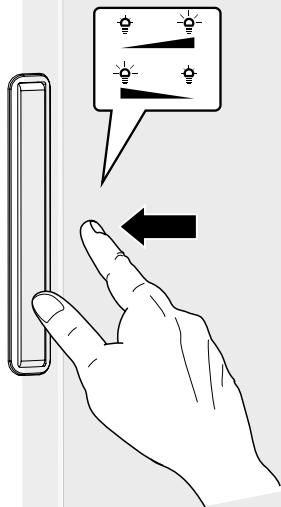

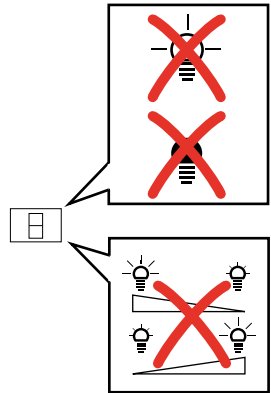
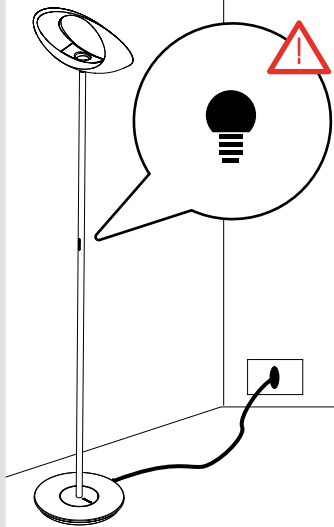
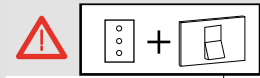
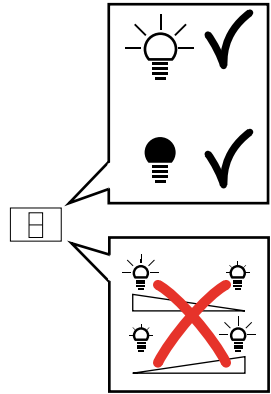
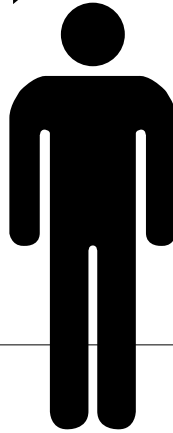
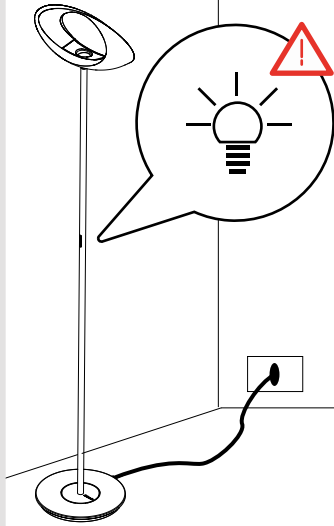
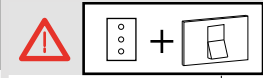

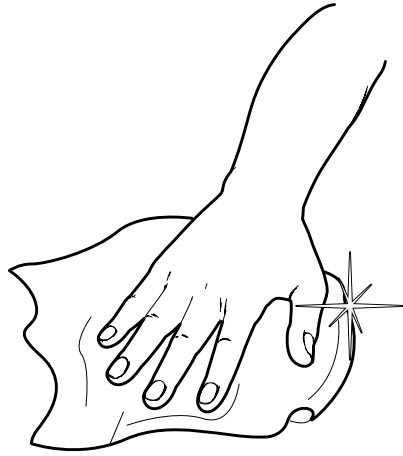
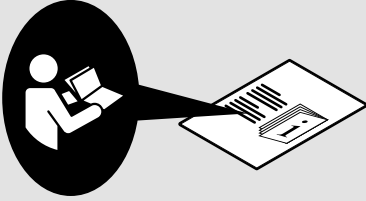

**Artemide®**

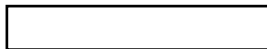

**Artemide**

via Bergamo, 18  
20006 Pregnana M.se (MI)  
ITALIA

tel. +39 02 935 181  
fax +39 02 935 90 254  
fax +39 02 935 90 496

[www.artemide.com](http://www.artemide.com)

VAT IT00846890150

cod. Y51300042A