

Artemide®

EGGBOARD CIRCLE 63 - 93 DIFFUSERS

design
Progetto CMR

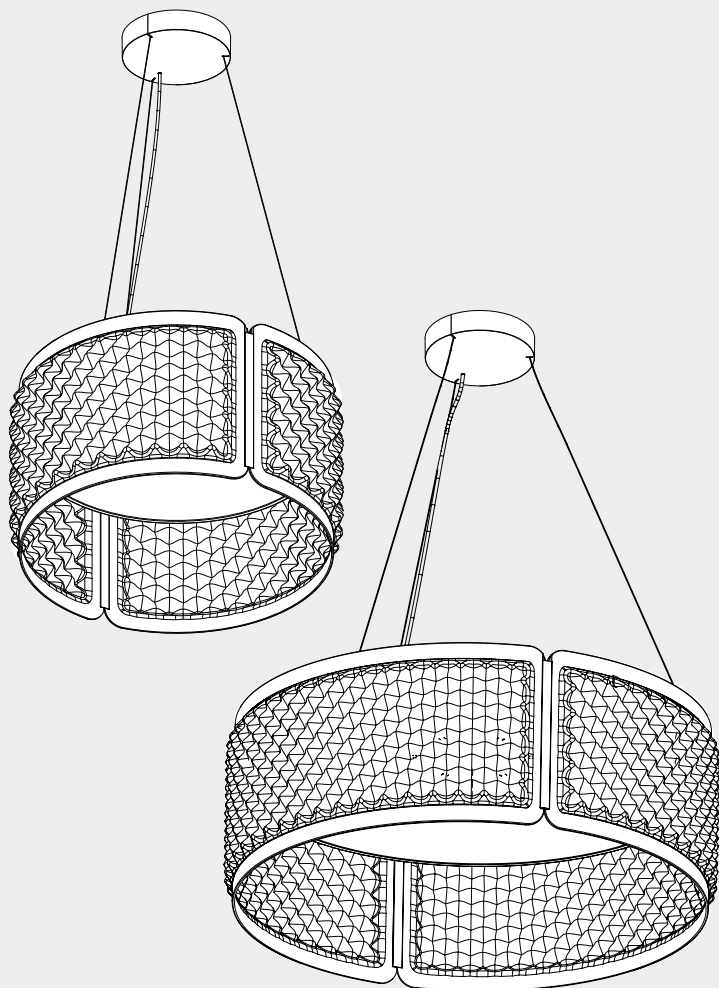



i

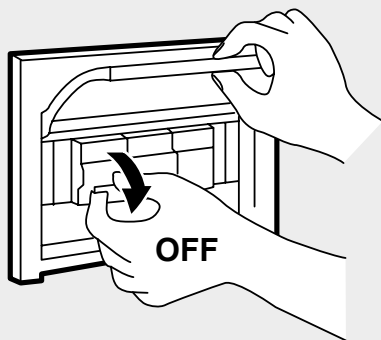
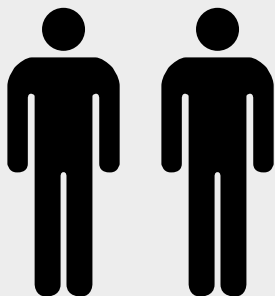

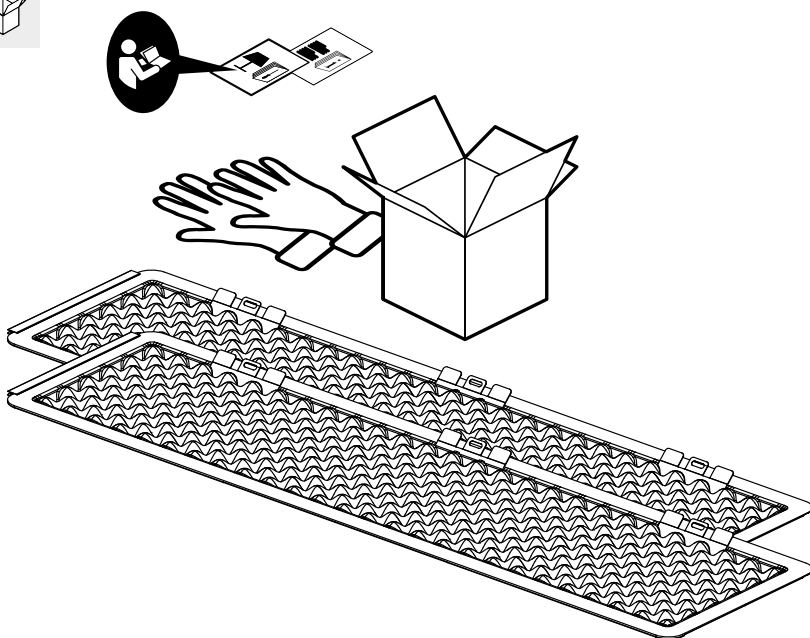
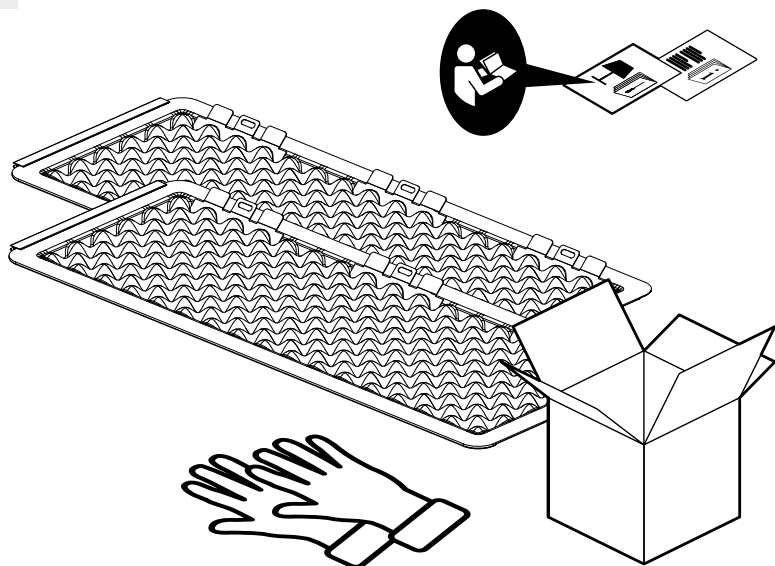

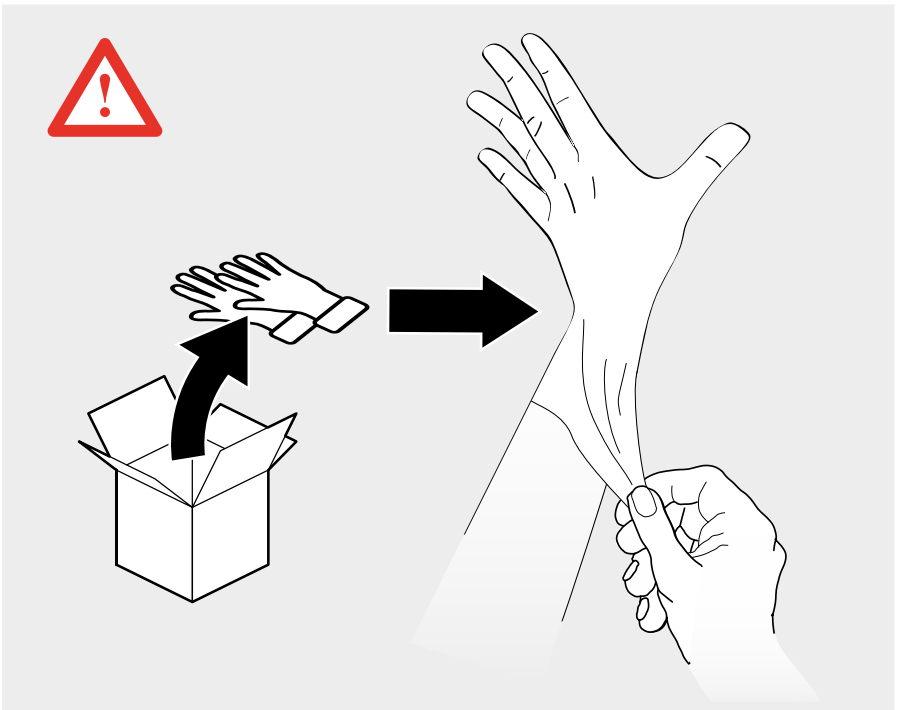
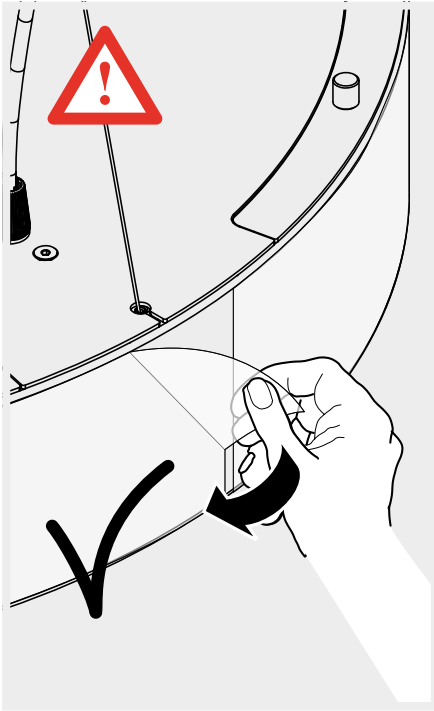

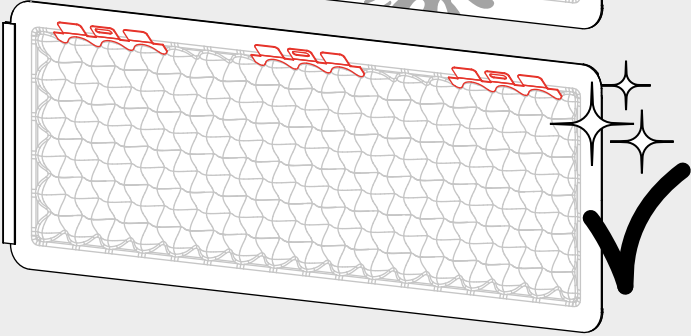
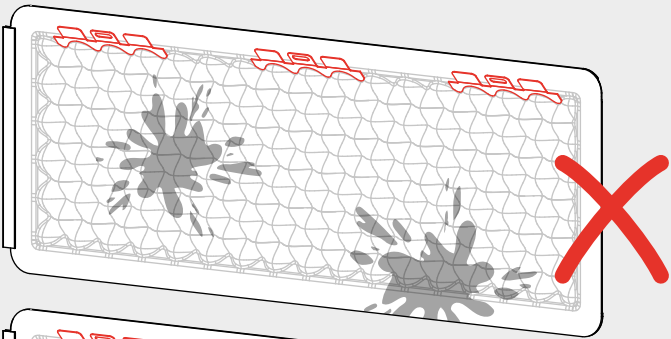

1

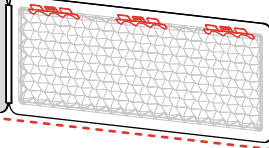
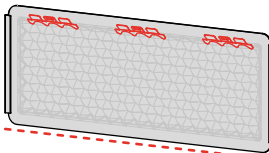
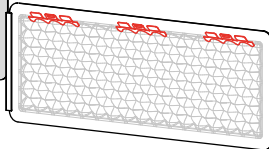
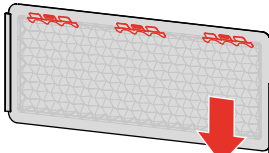
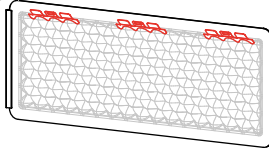
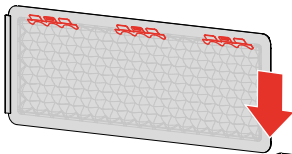

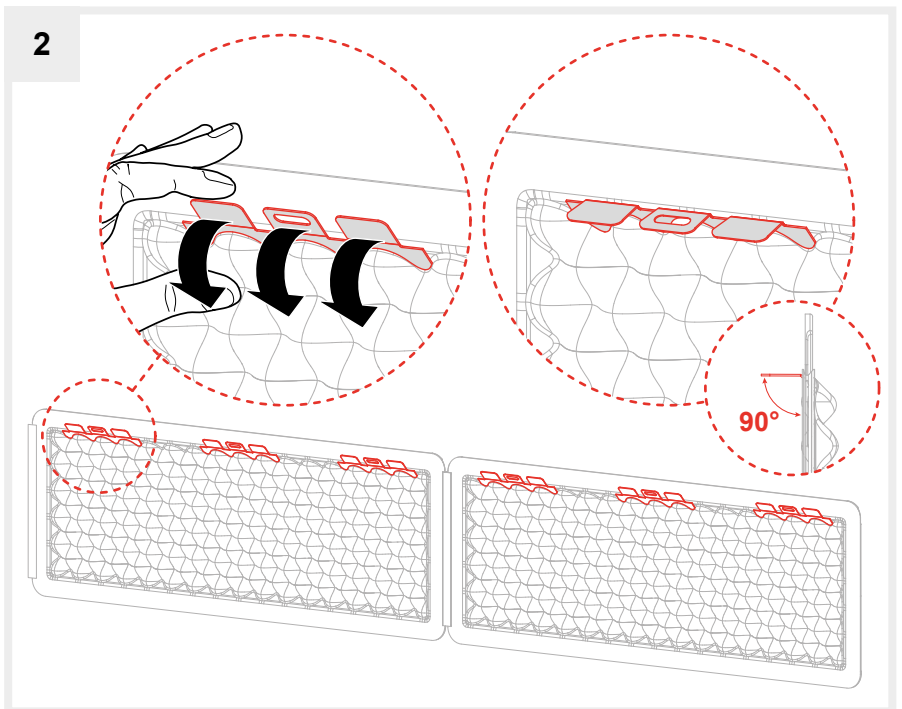
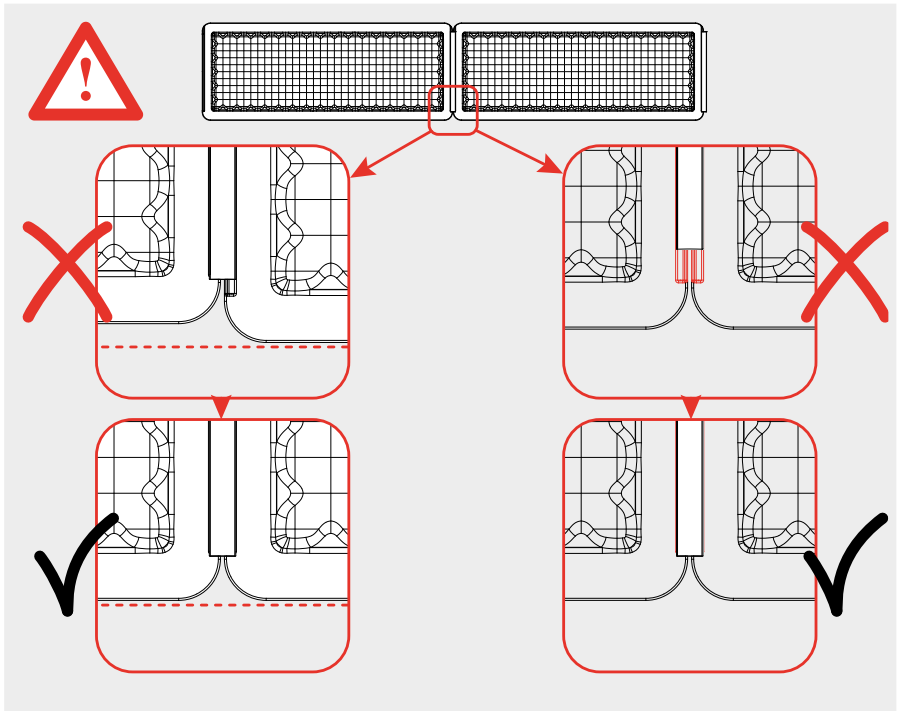

3

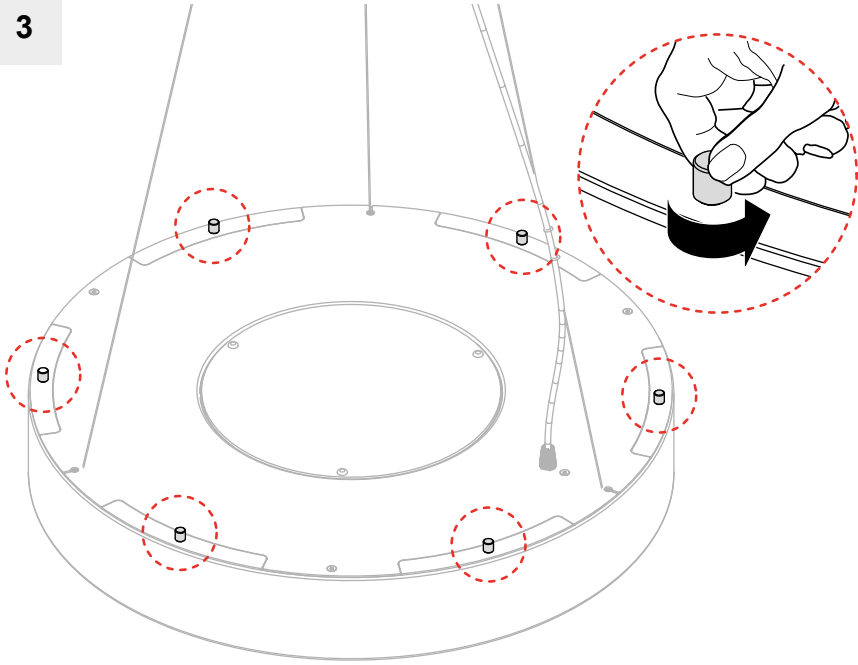

4

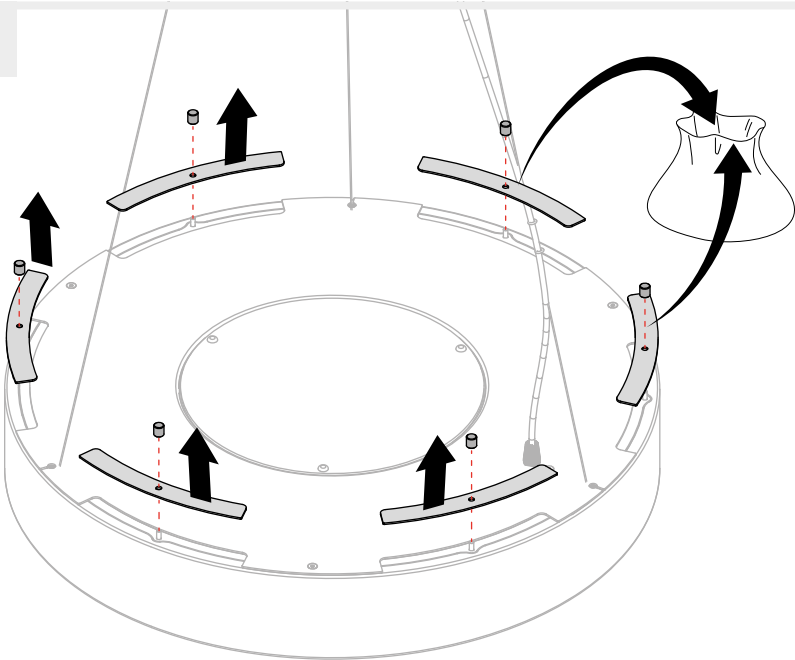

5

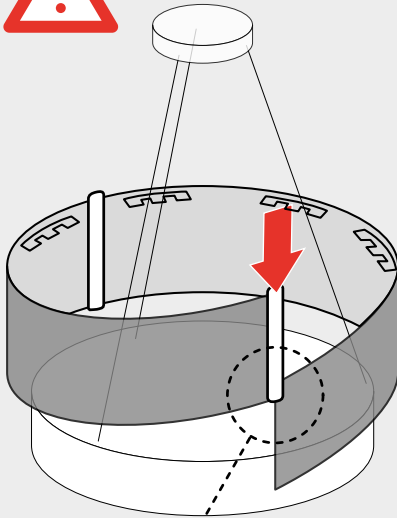
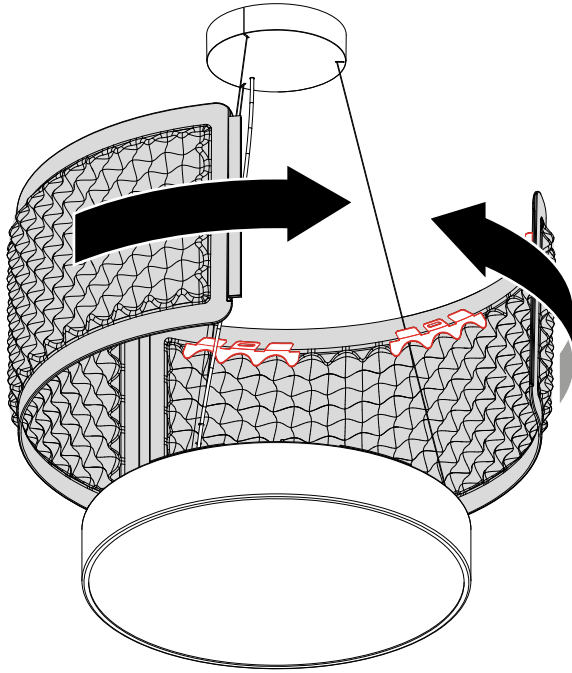
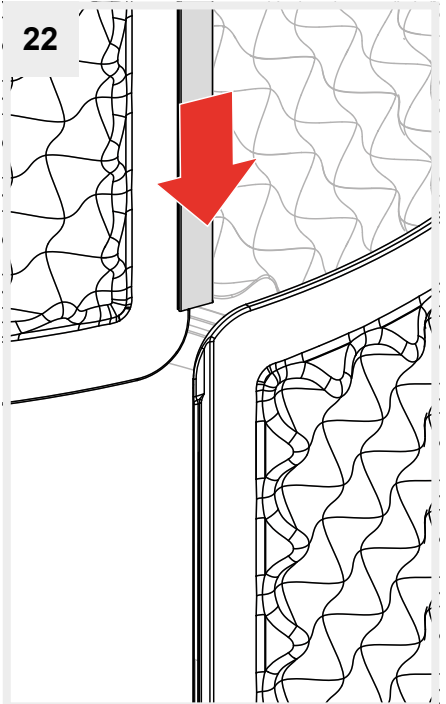
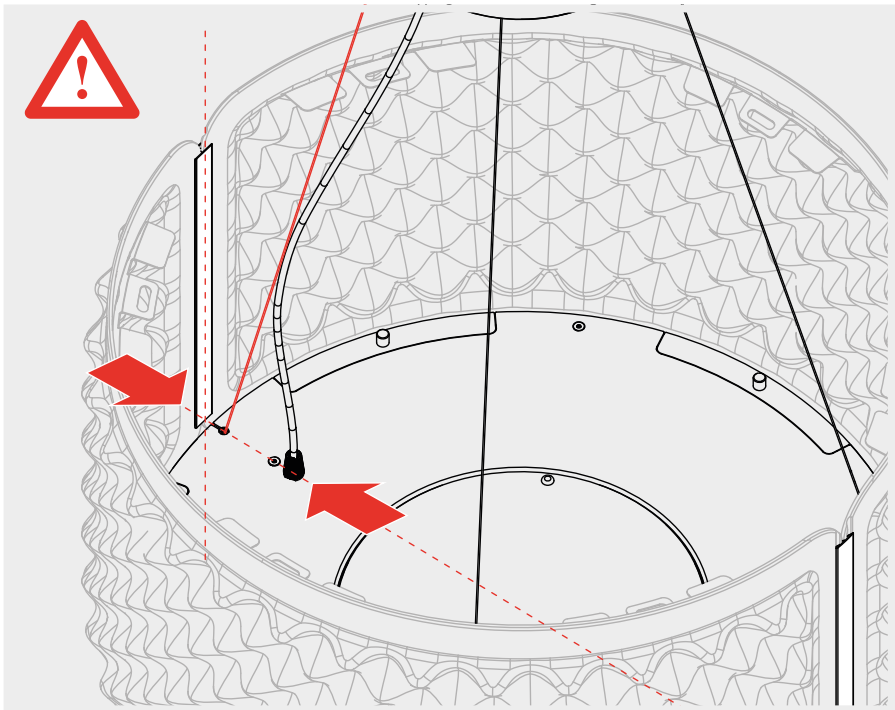
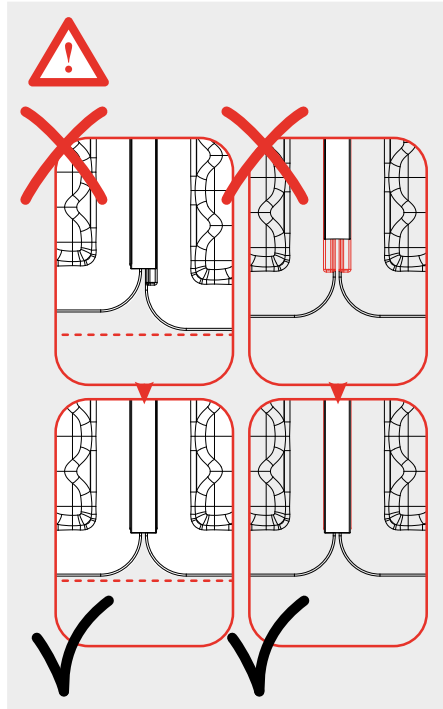
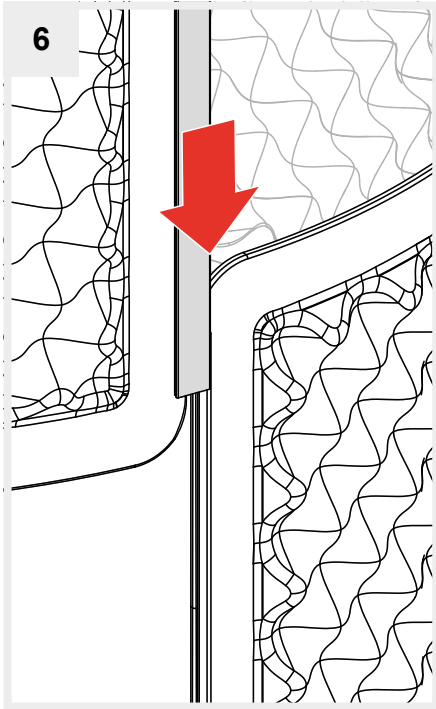

Fig. 22

22





7

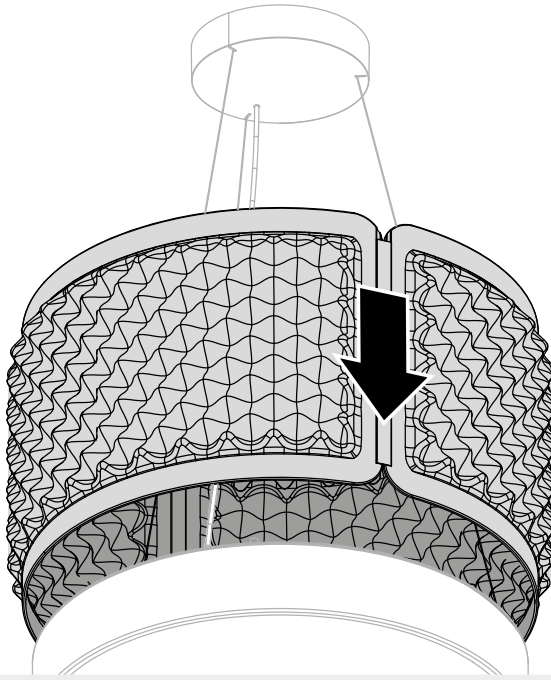

8

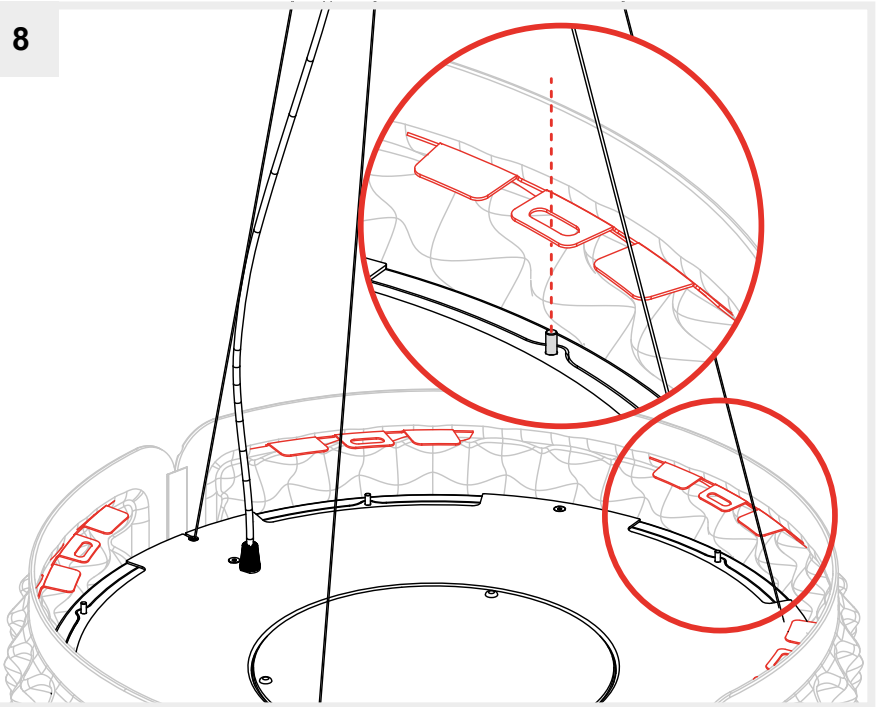

9

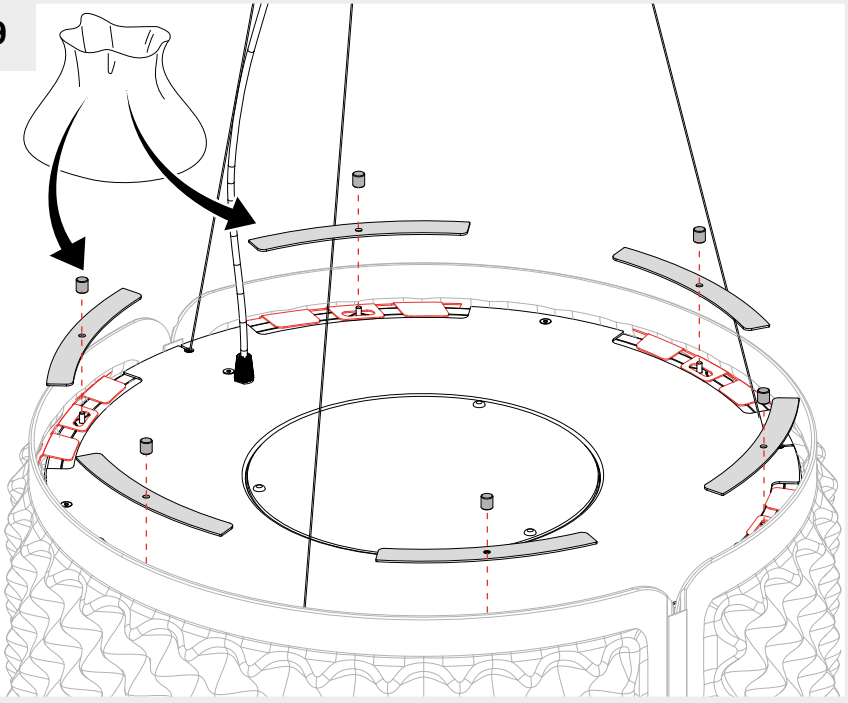

10

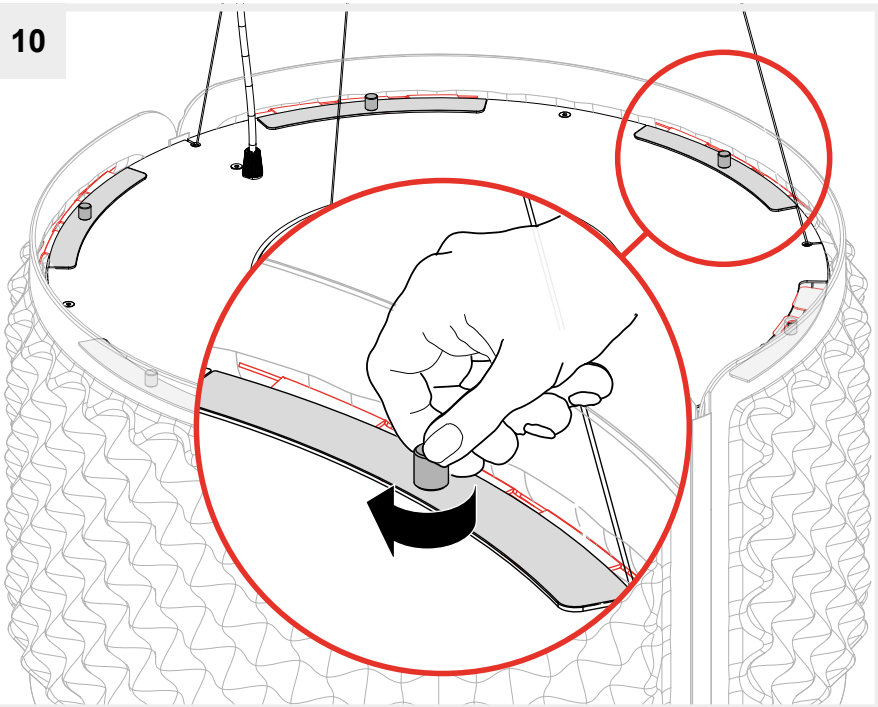

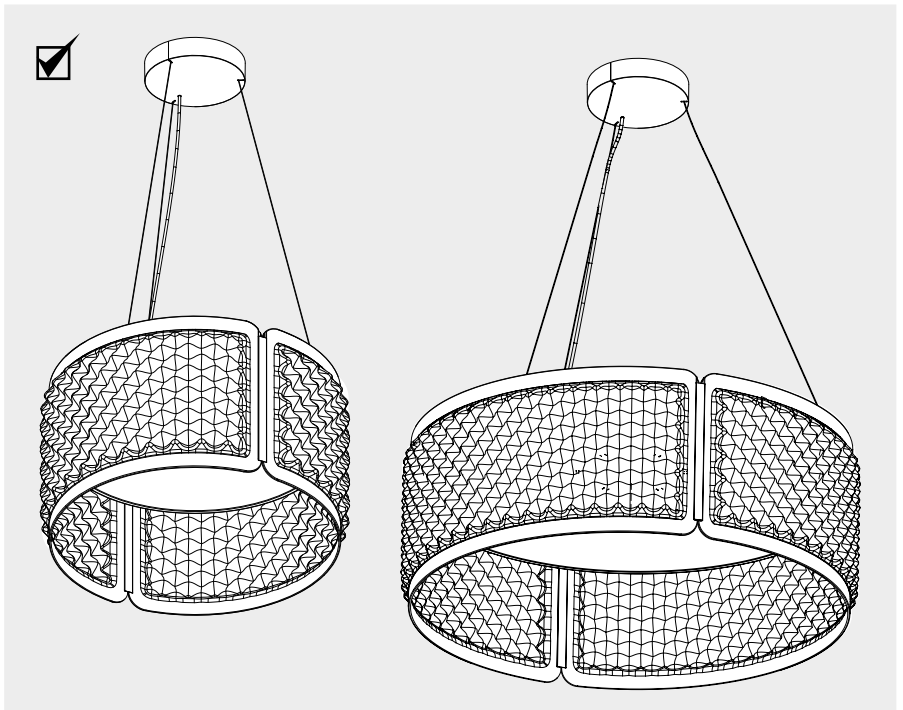
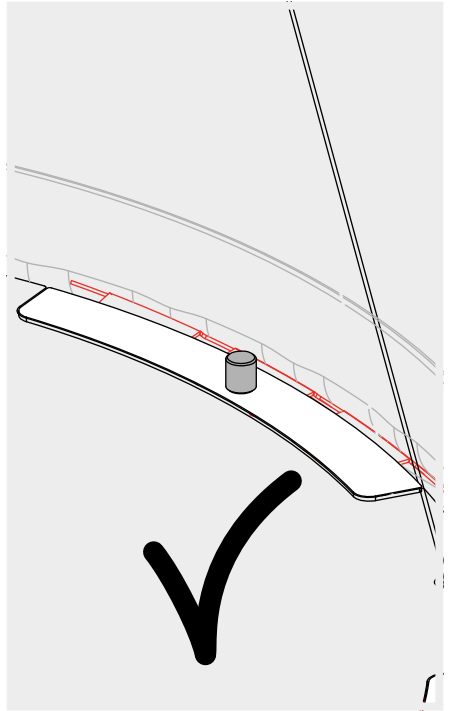
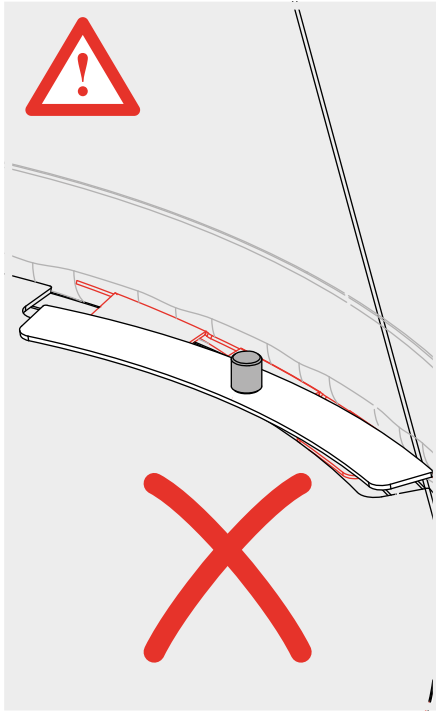

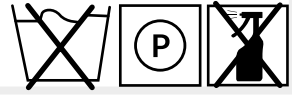
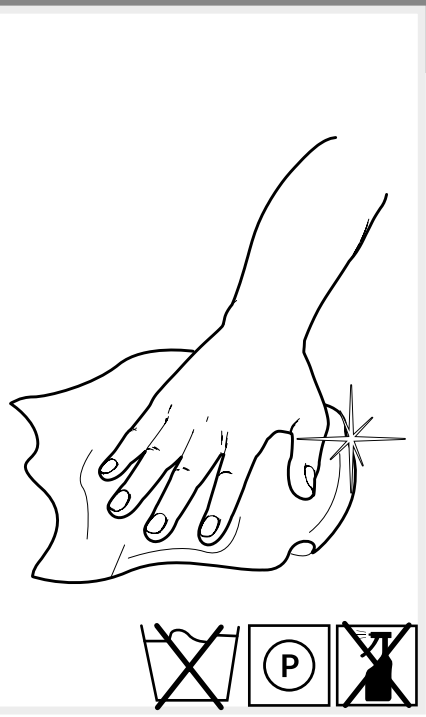
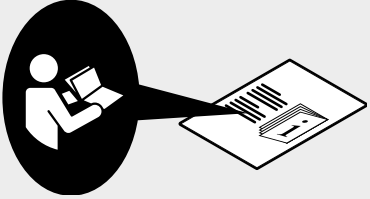

Artemide®

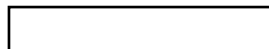

Artemide

via Bergamo, 18
20006 Pregnana M.se (MI)
ITALIA

tel. +39 02 935 181
fax +39 02 935 90 254
fax +39 02 935 90 496

www.artemide.com

VAT IT00846890150

cod. Y513001992