

Artemide®

Pipe LED

design
Herzog & De Meuron

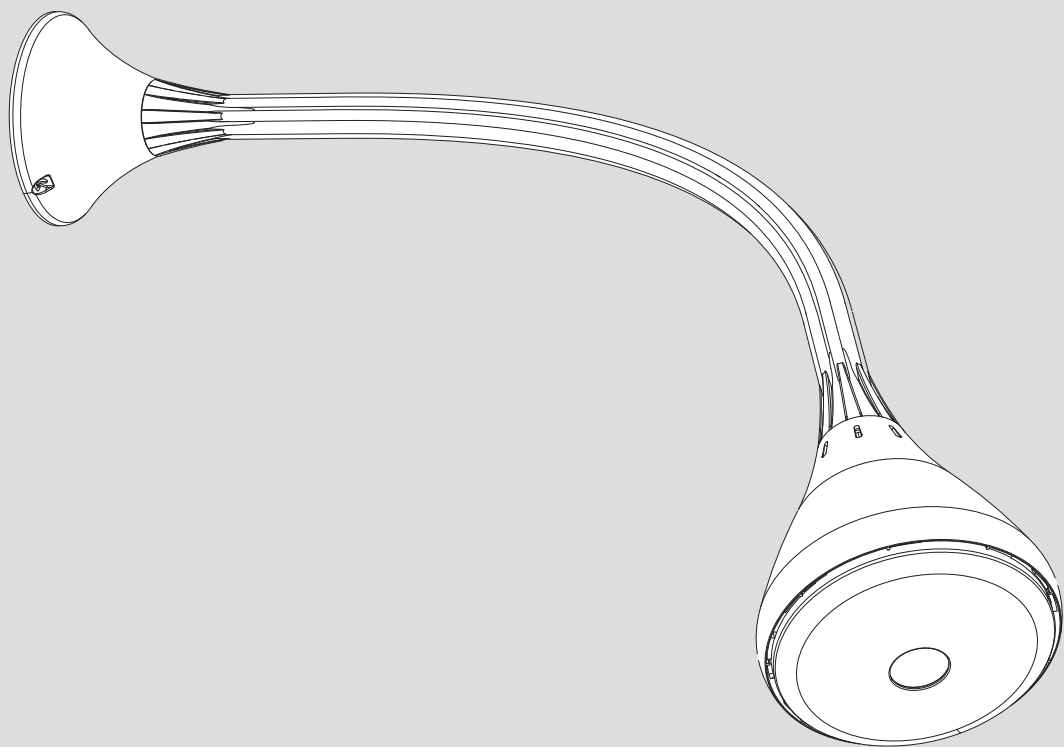



i

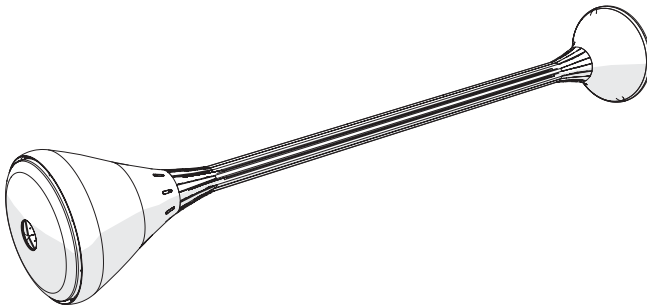
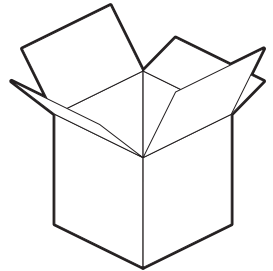
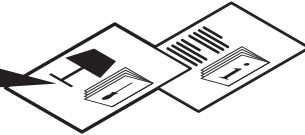

1



2

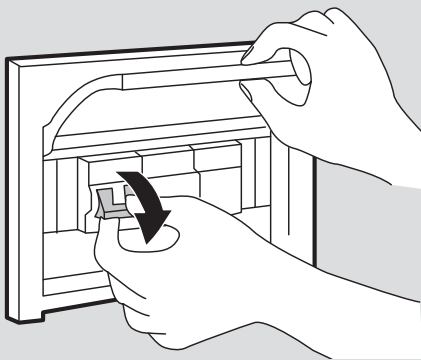
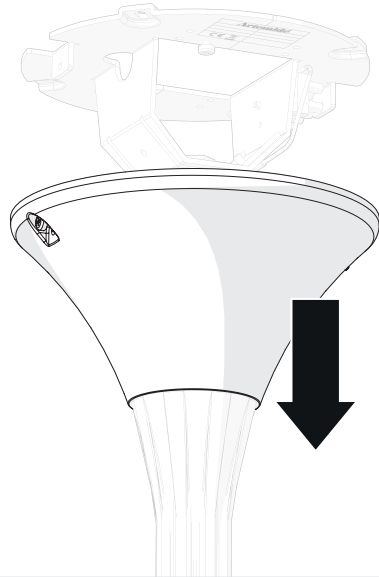

3

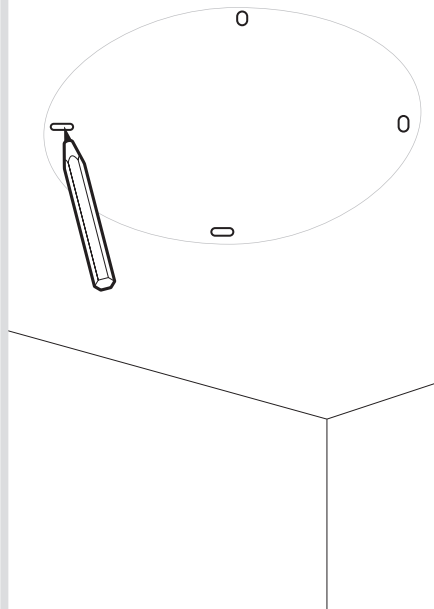

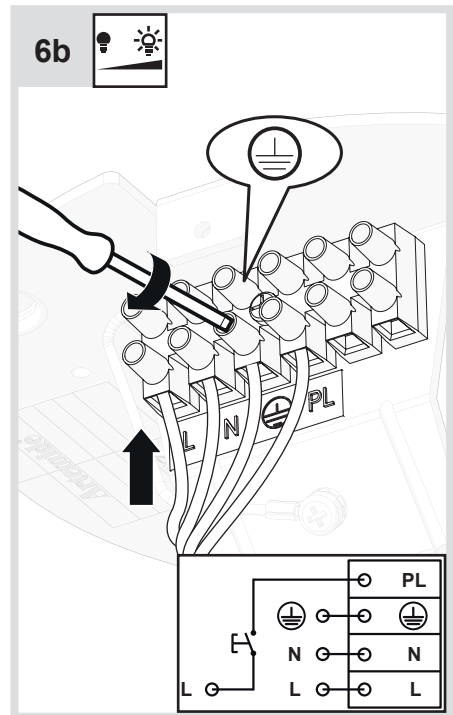
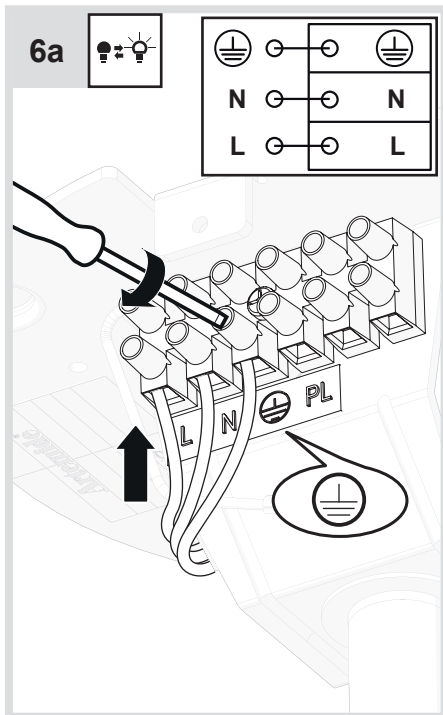
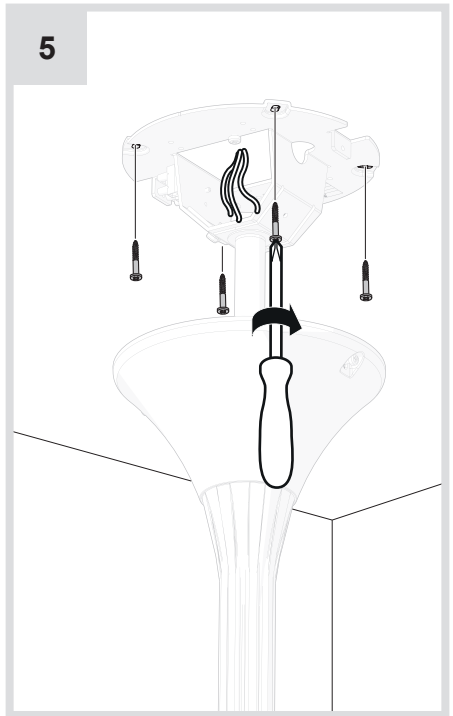
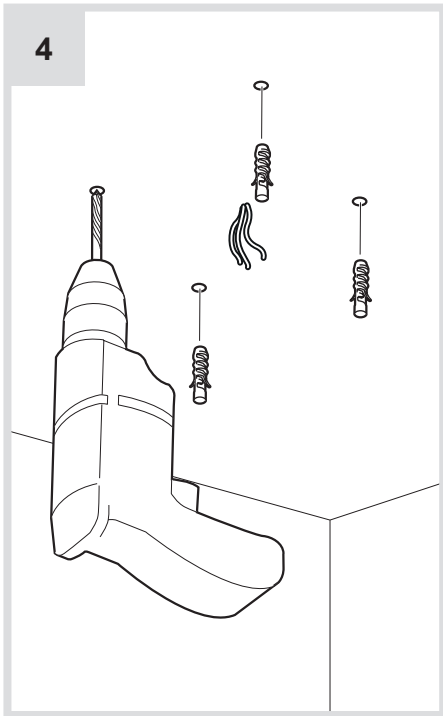

8

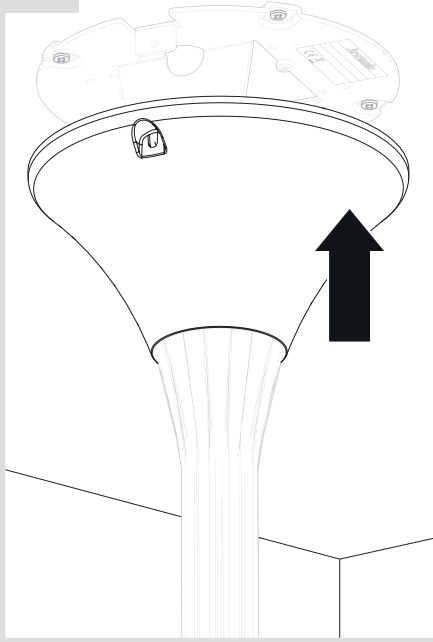

9

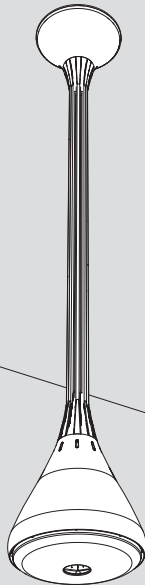
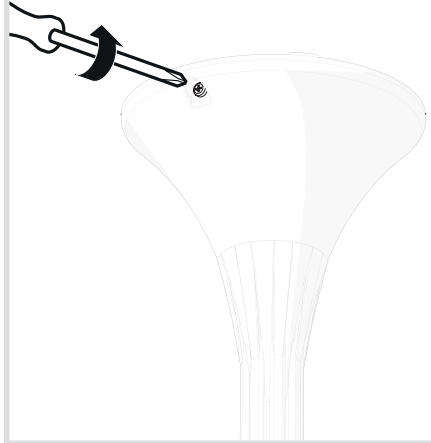



i

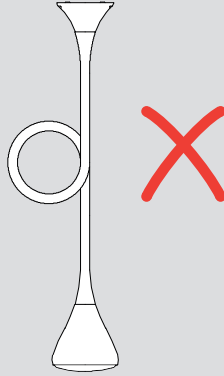
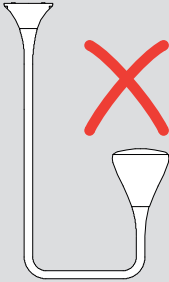
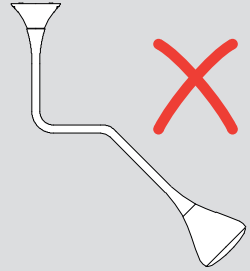
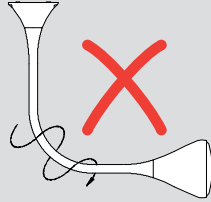
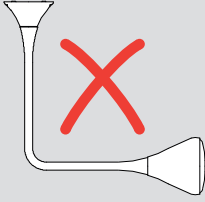

i

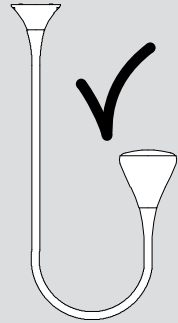
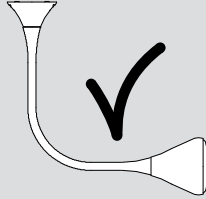
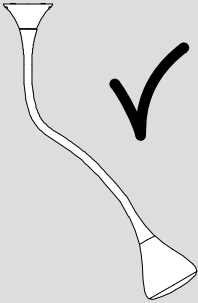

≥ 20 cm

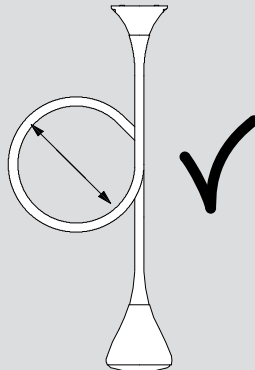



i

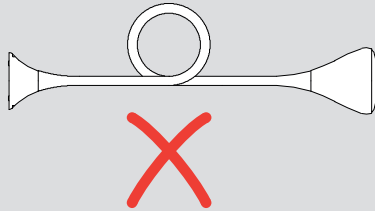
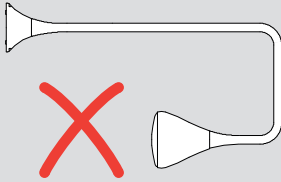
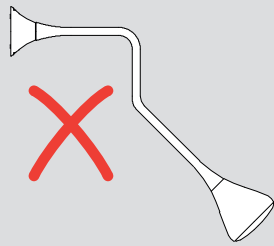

i

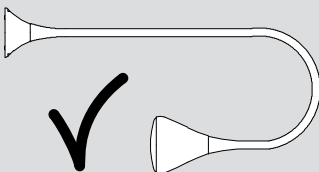
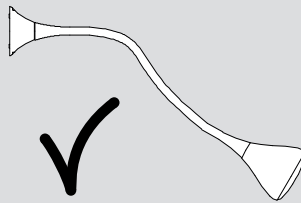
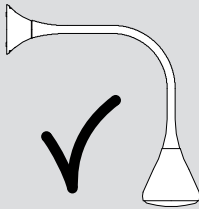

≥ 20 cm

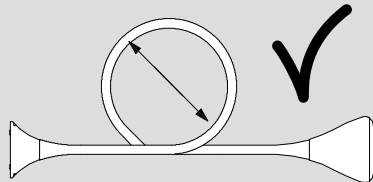

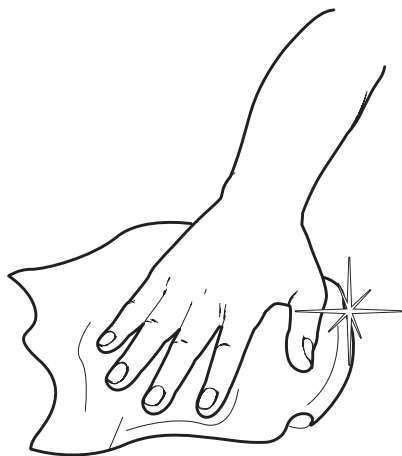

Artemide®

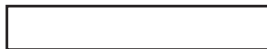

Artemide

via Bergamo, 18
20010 Pregnana M.se (MI)
ITALIA

tel. +39 02 935 181
fax +39 02 935 90 254
fax +39 02 935 90 496

www.artemide.com

VAT IT00846890150

cod. Y513000374