

Artemide®

Nur

design
Ernesto Gismondi

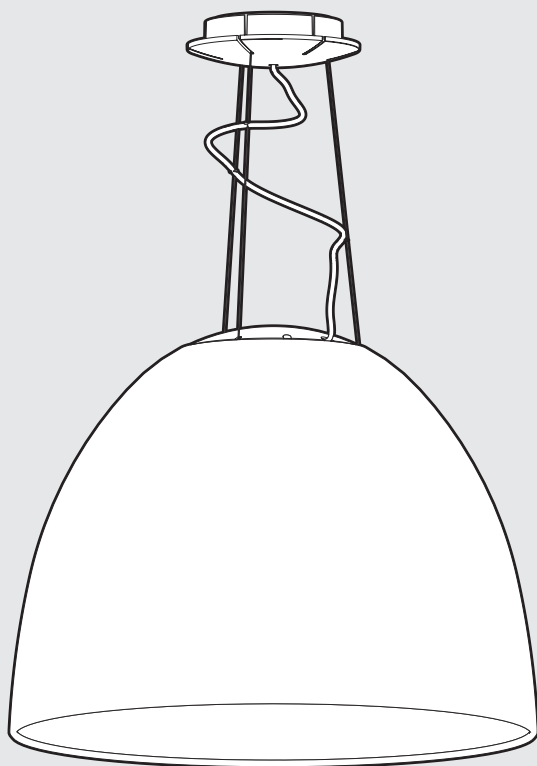



i

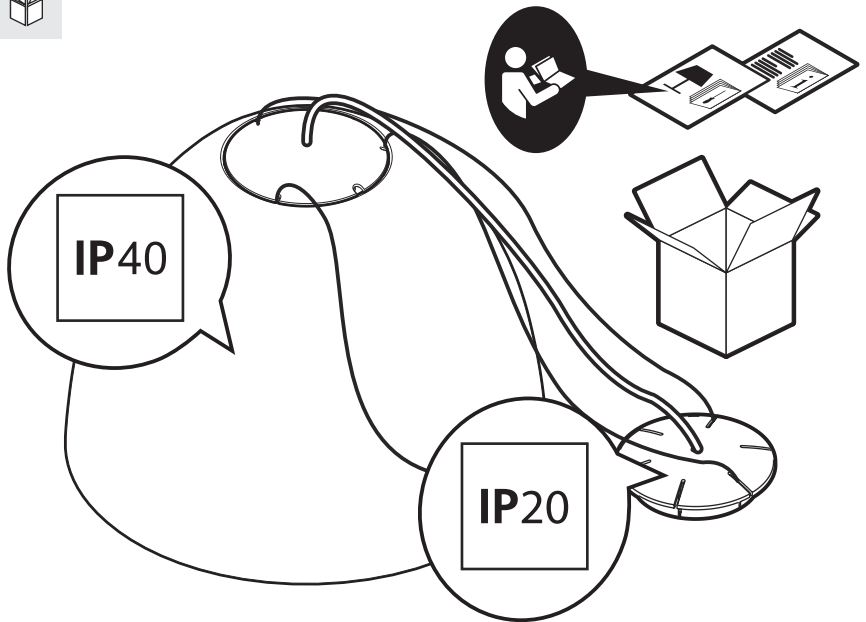
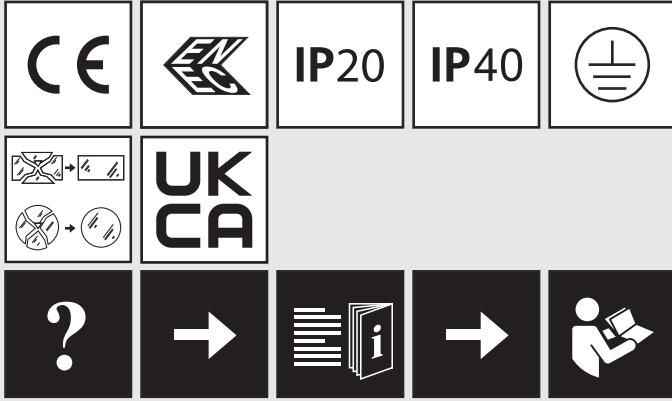

1



2

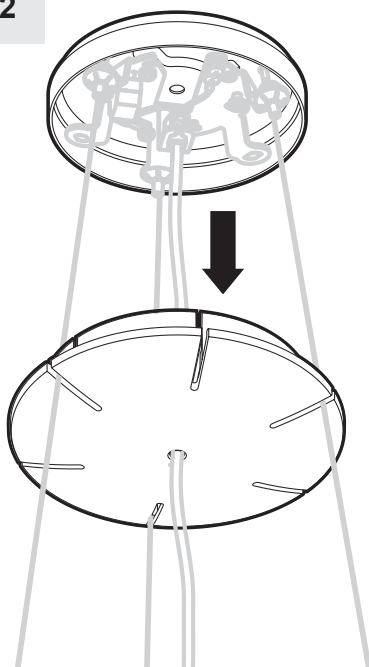

3

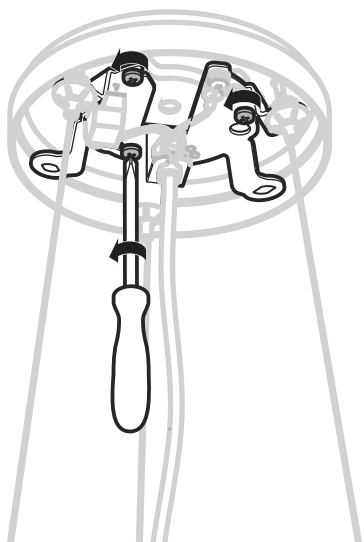

4

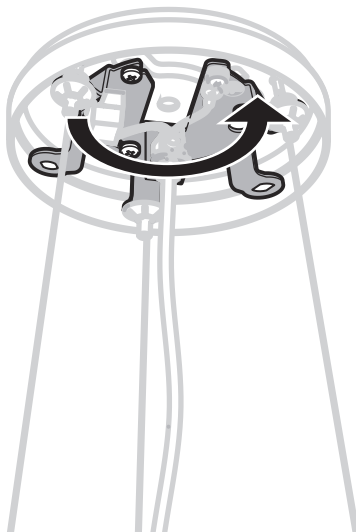

5

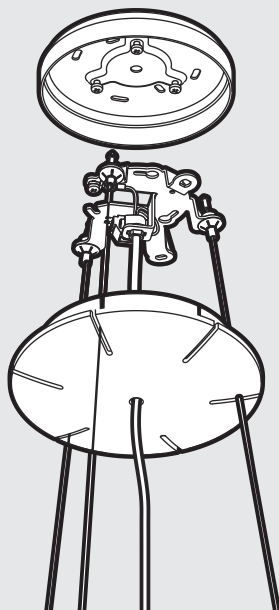
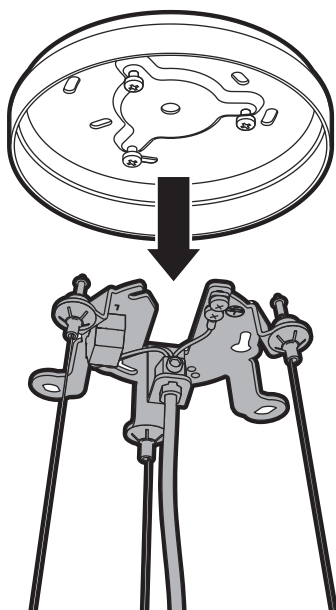

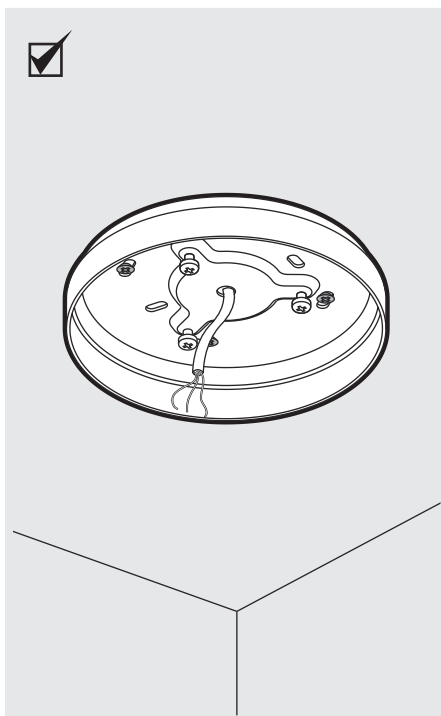
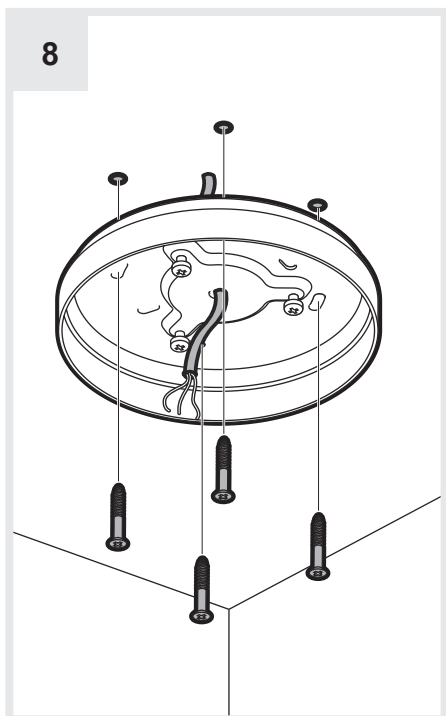
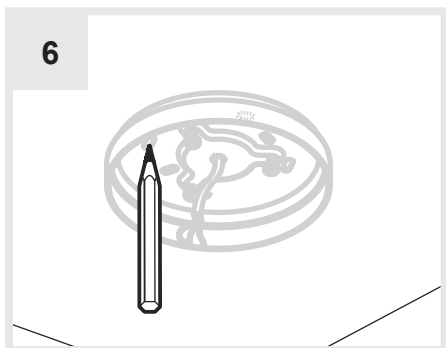
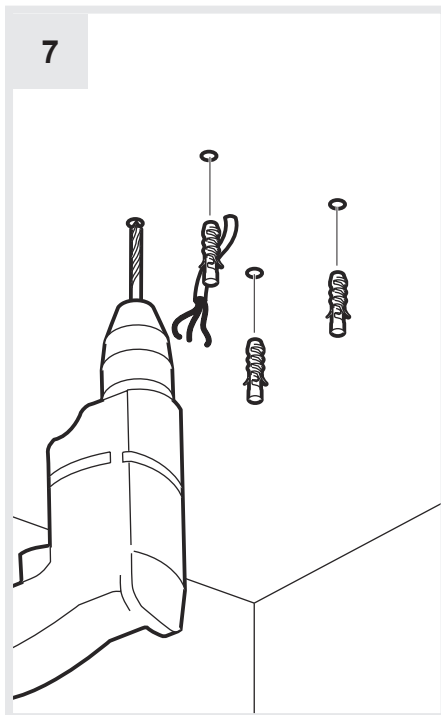
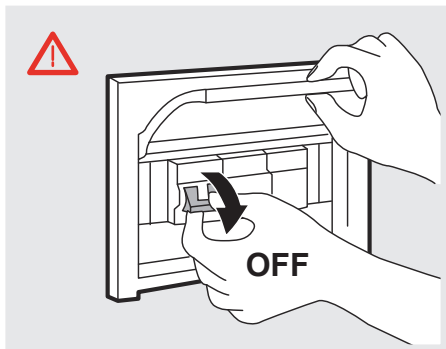

9

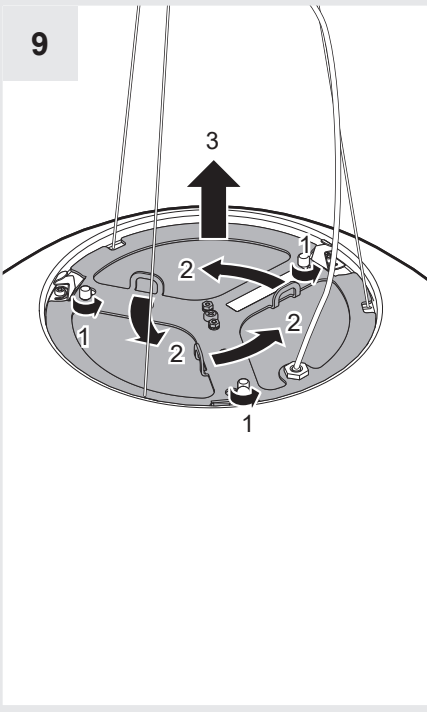

10

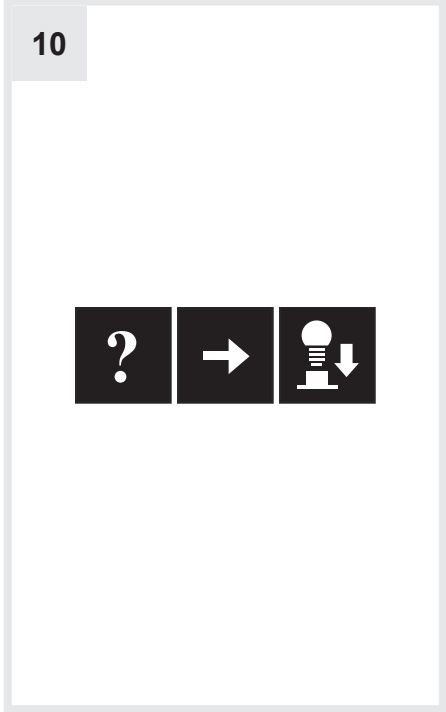

11

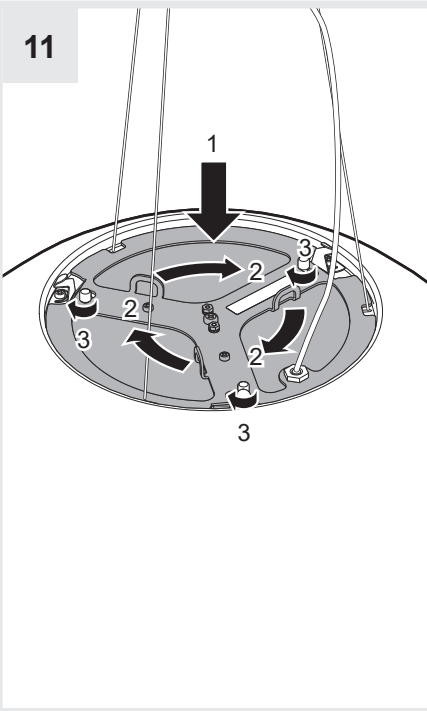

12

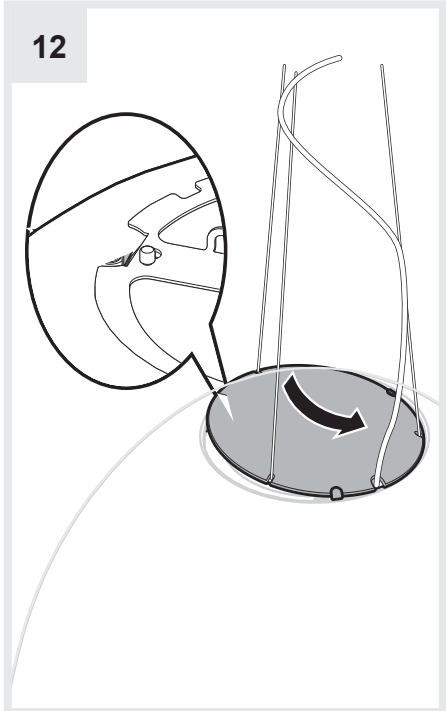

i

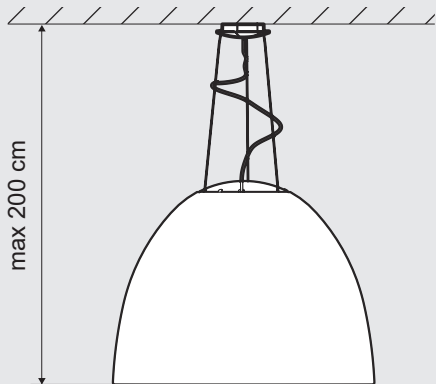

13

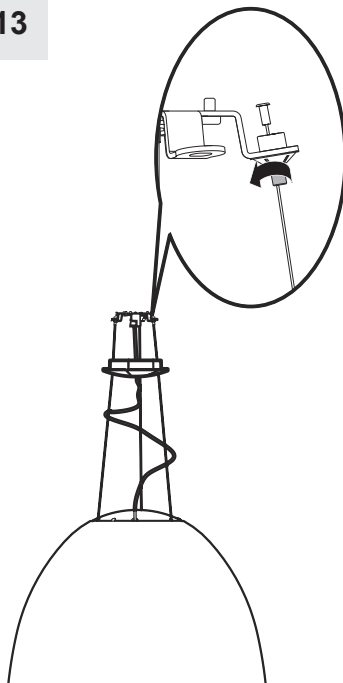

14

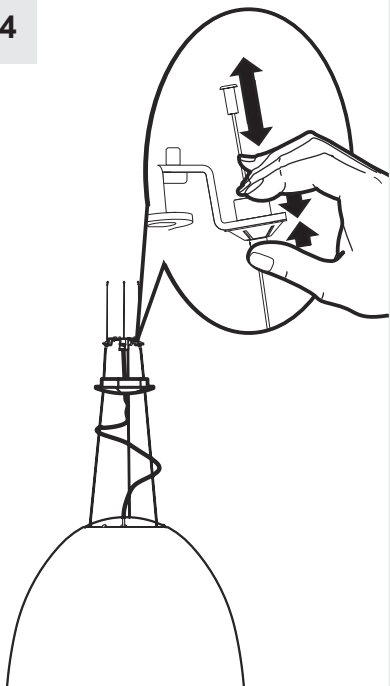

15

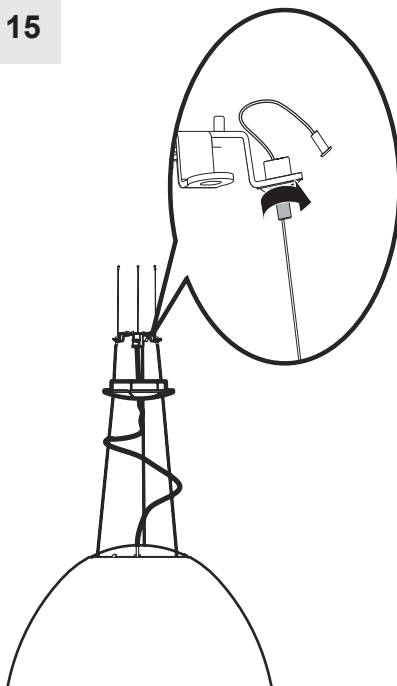

16

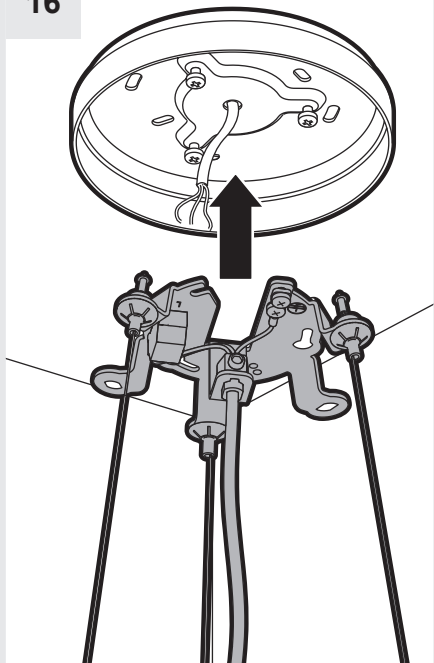

17



18

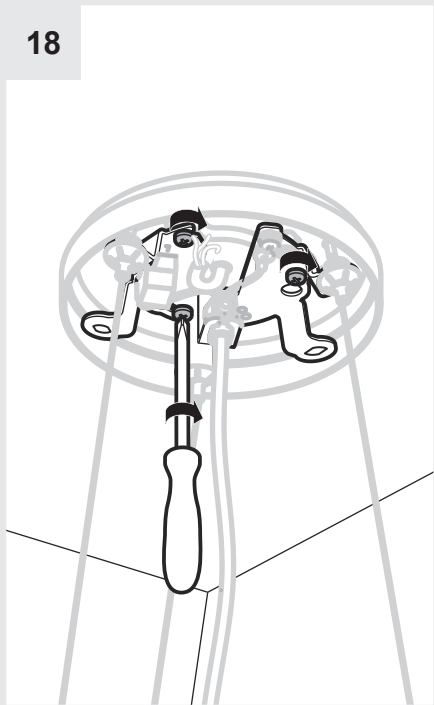

19

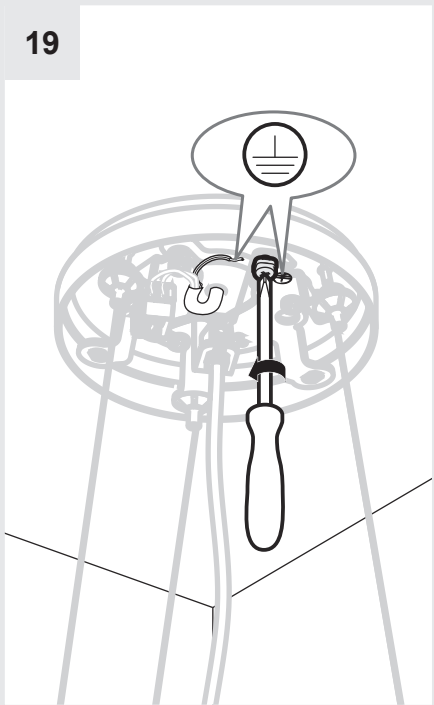

20

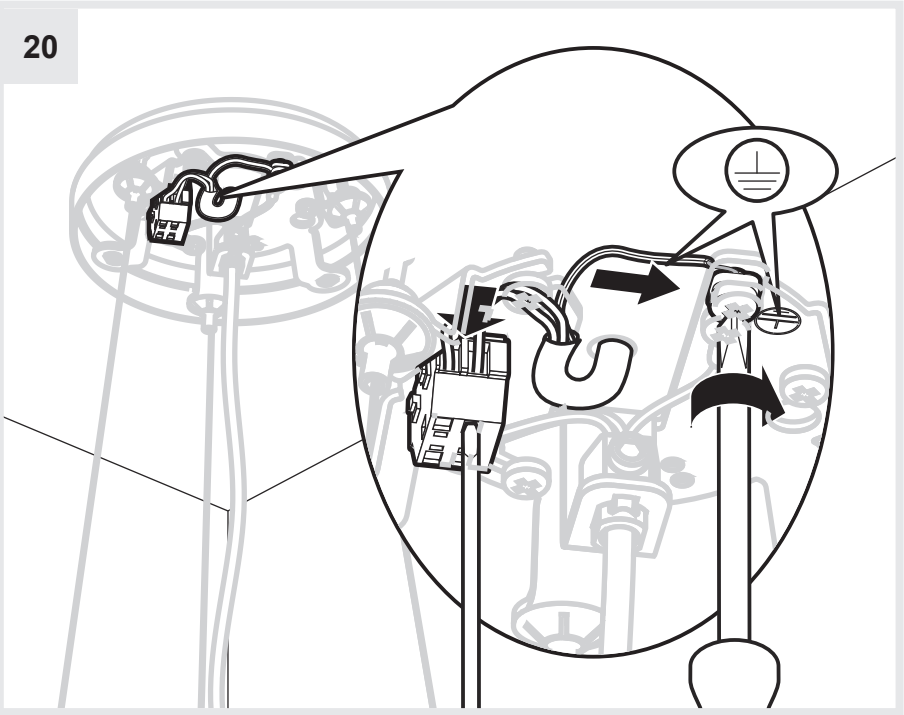

21

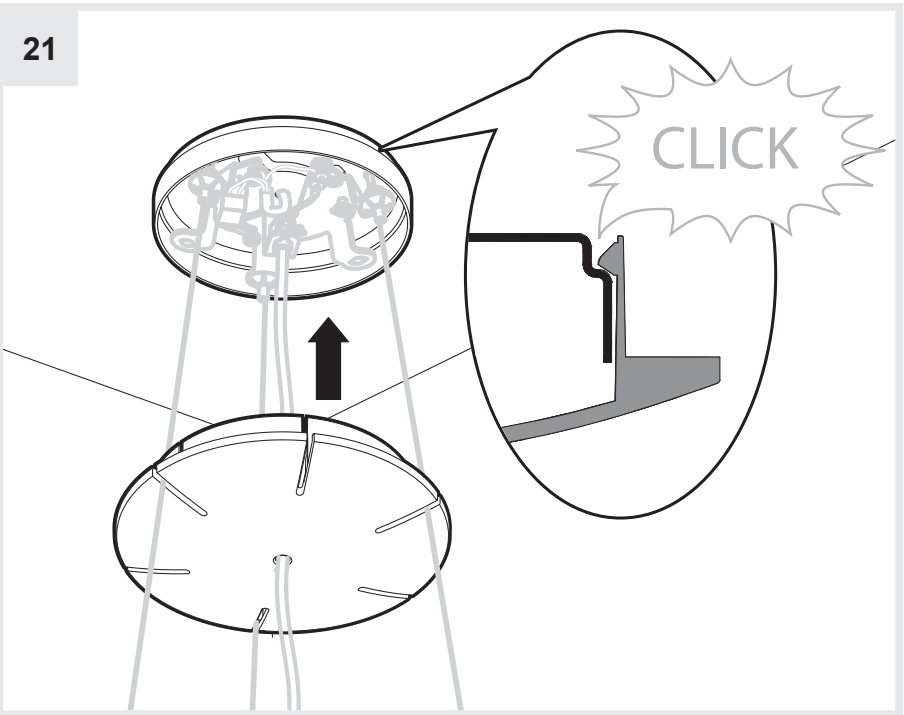

22

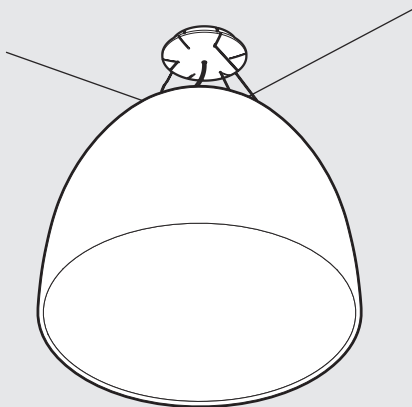
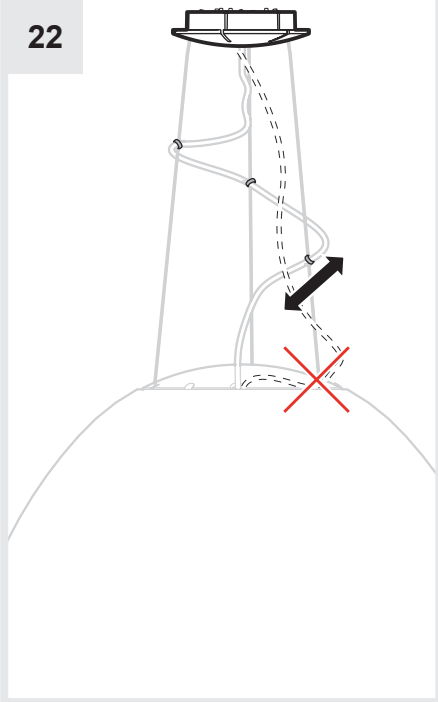

1

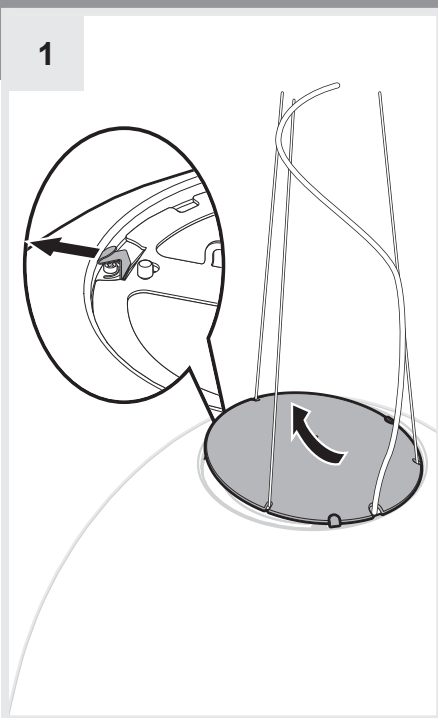

2

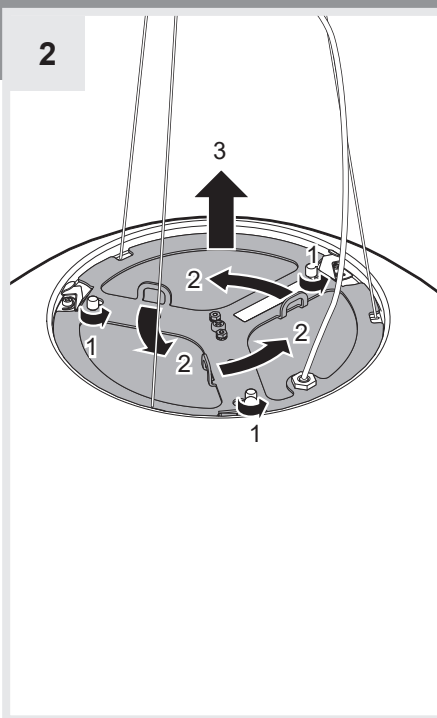

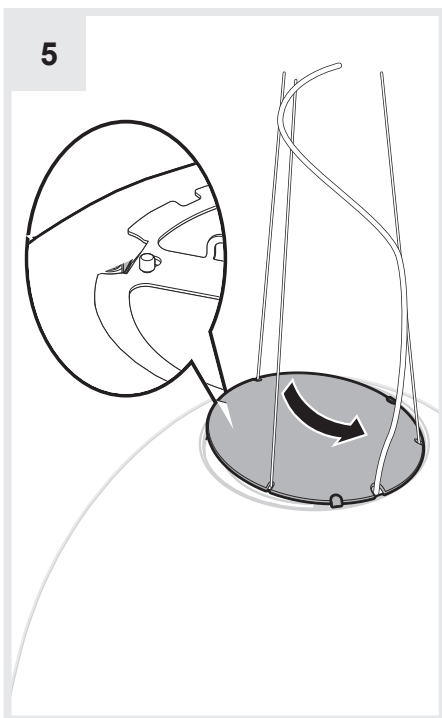
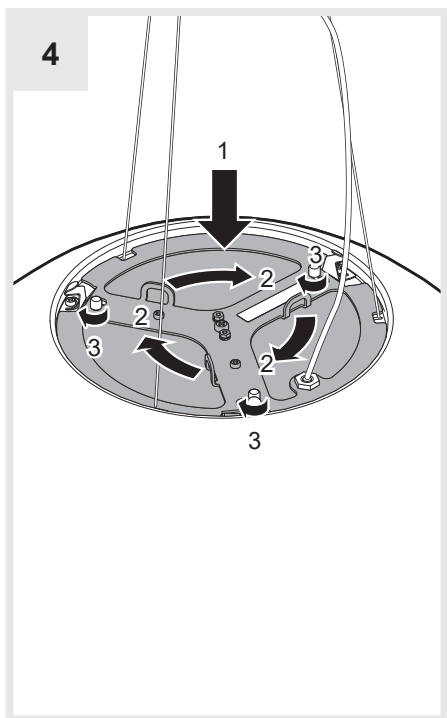
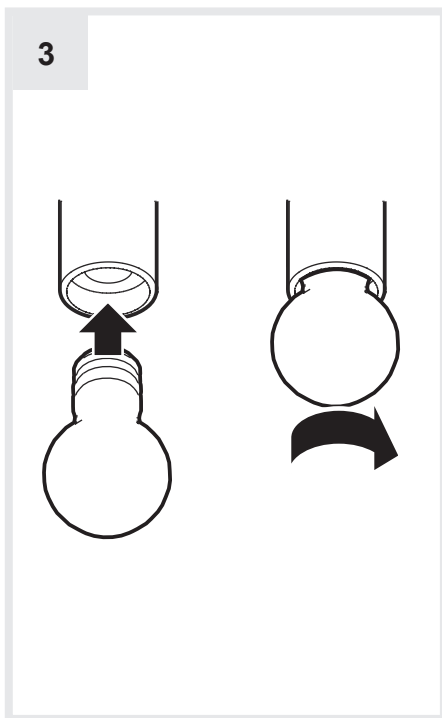
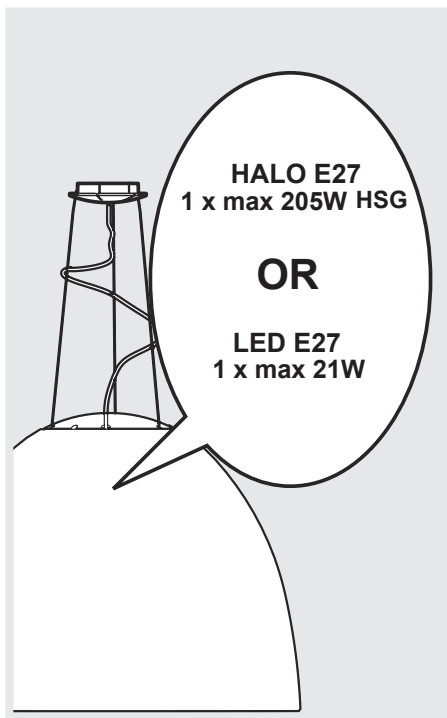

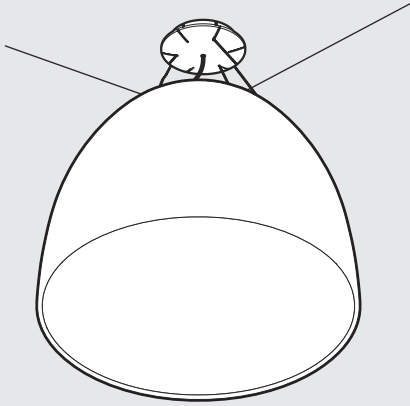

i



1

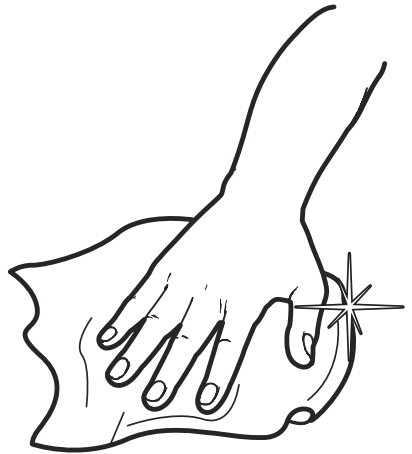

Artemide®



Artemide

via Bergamo, 18
20006 Pregnana M.se (MI)
ITALIA

tel. +39 02 935 181
fax +39 02 935 90 254
fax +39 02 935 90 496

www.artemide.com

VAT IT00846890150

cod. Y513000021B