

## Reeds

design  
Klaus Begasse

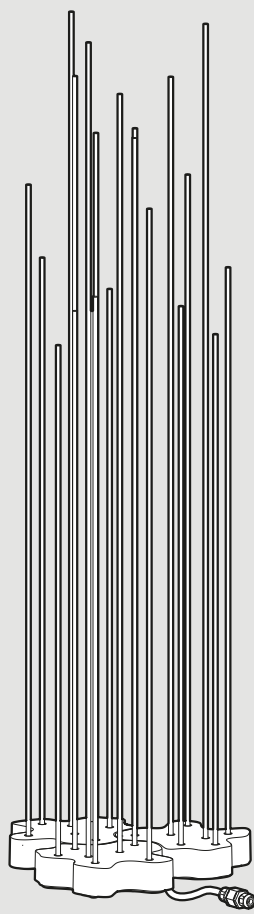

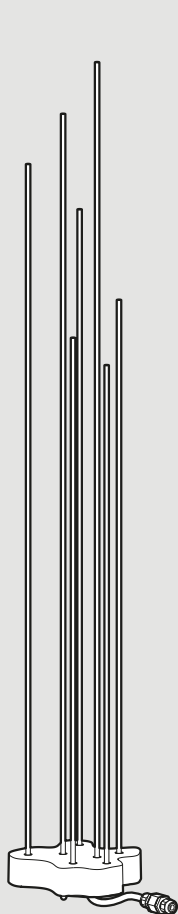

i

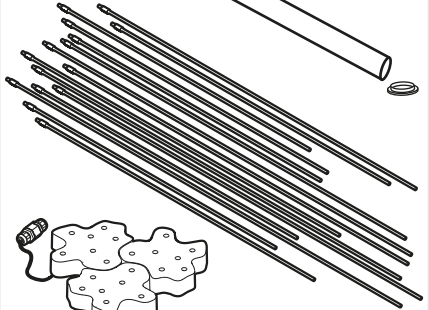
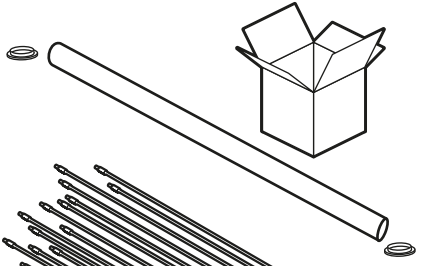
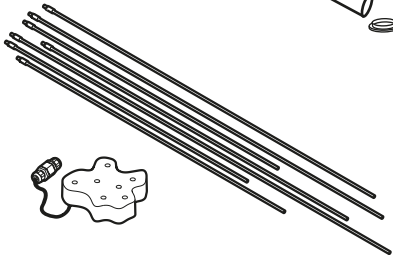
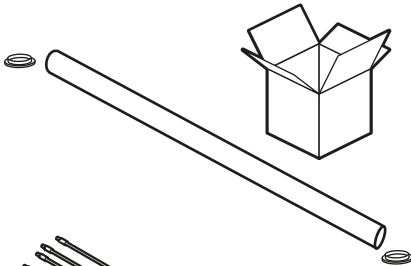
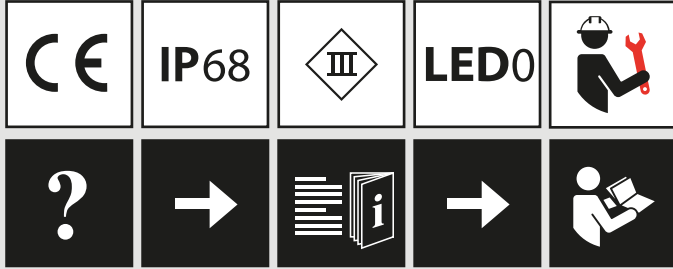

**i**

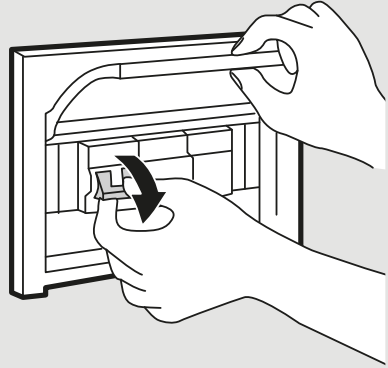
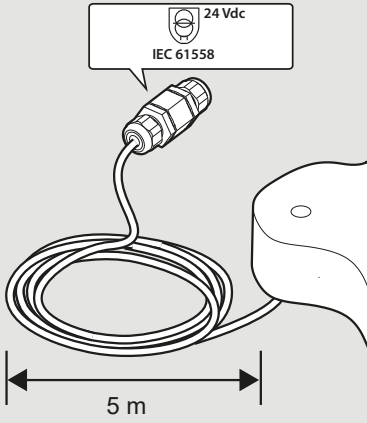

**1**

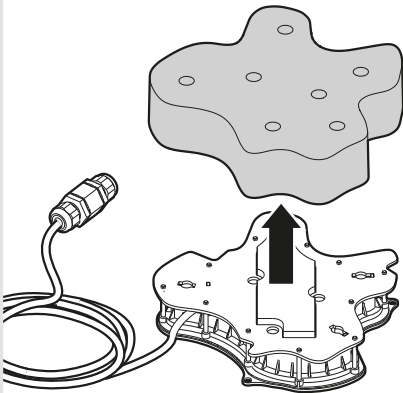

**2**

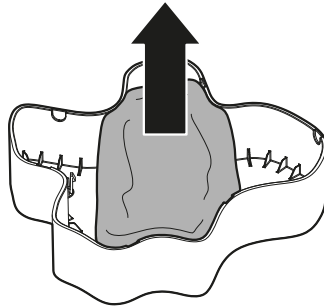

3

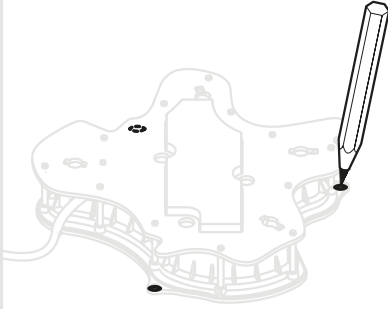

4

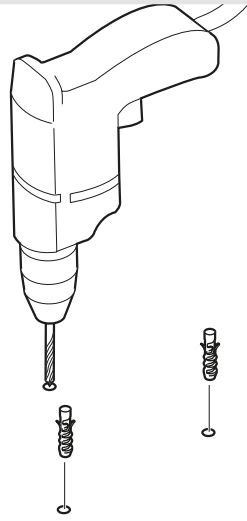

5a

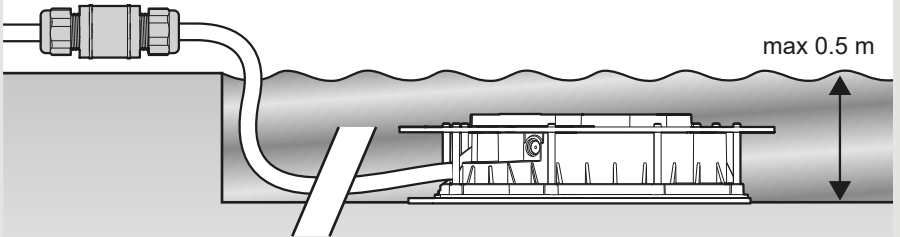

5b

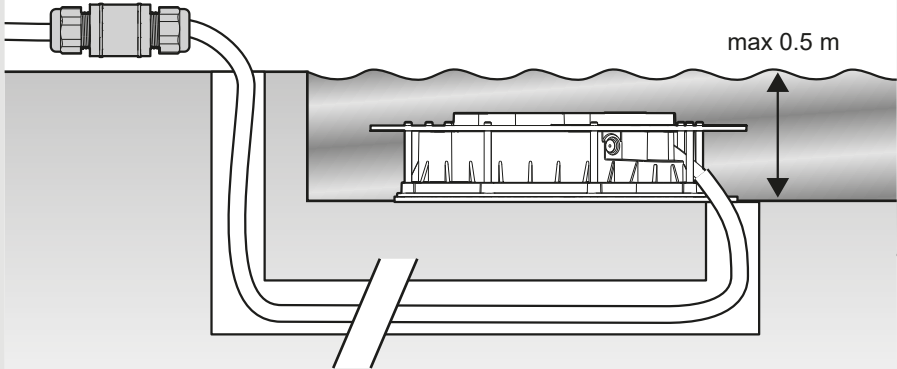

6

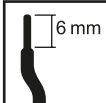
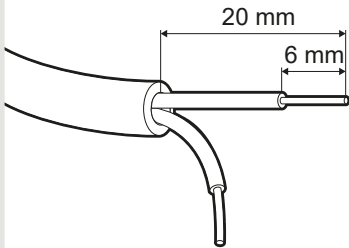

7

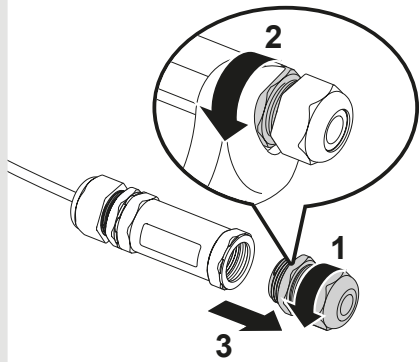

8

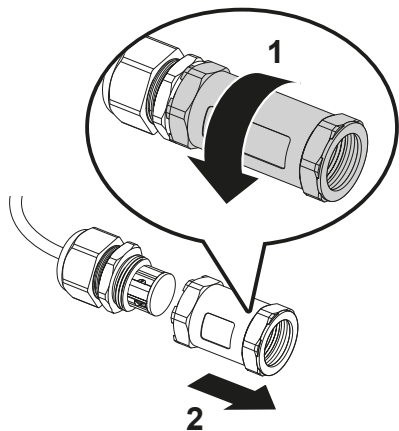

9

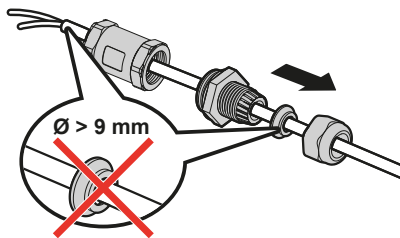

10

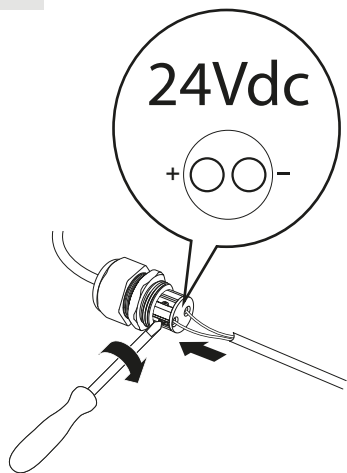

11

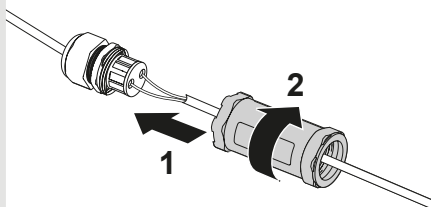

12

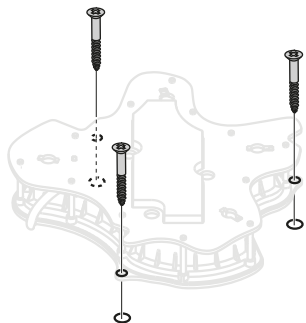

13

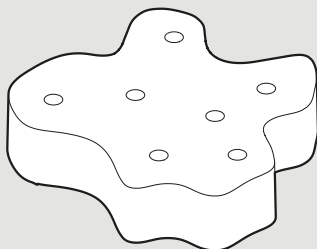
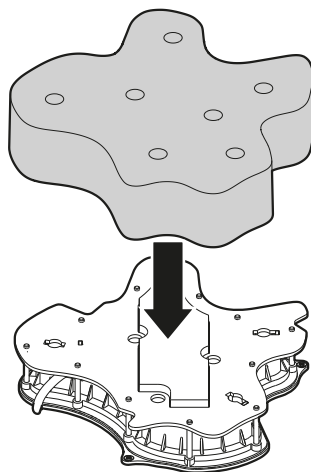

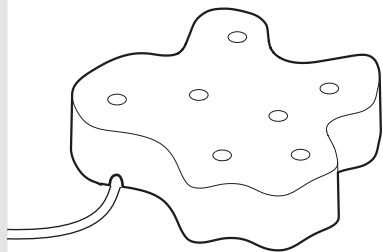

**i**

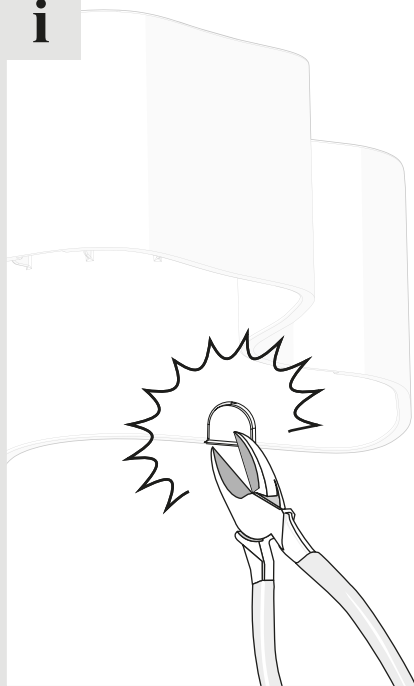

**i**

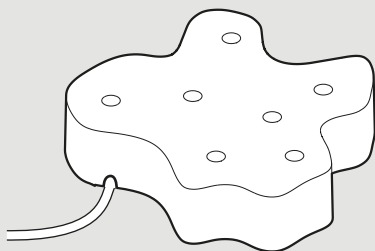
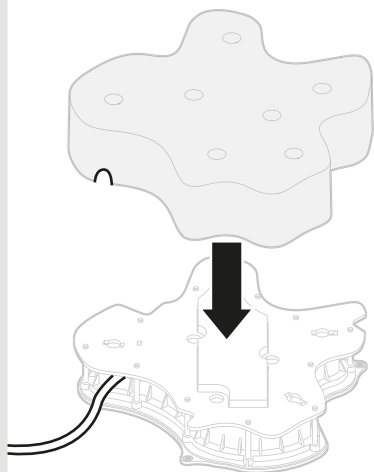



14

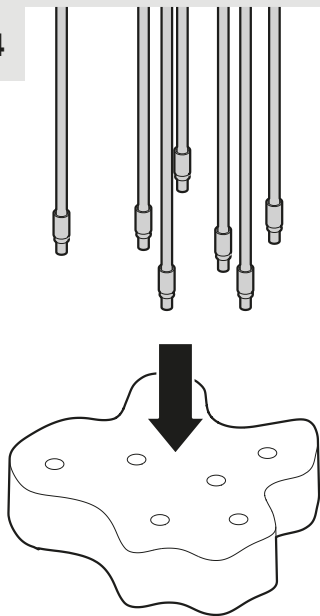

15

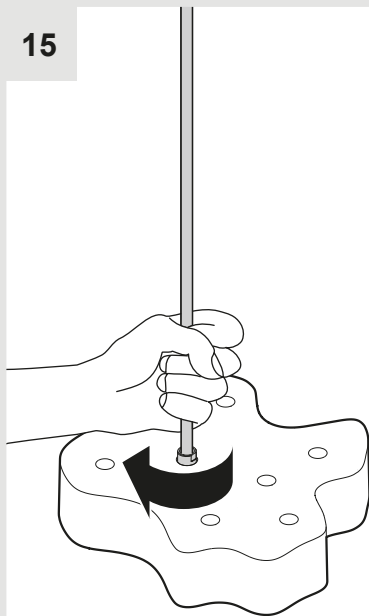

16

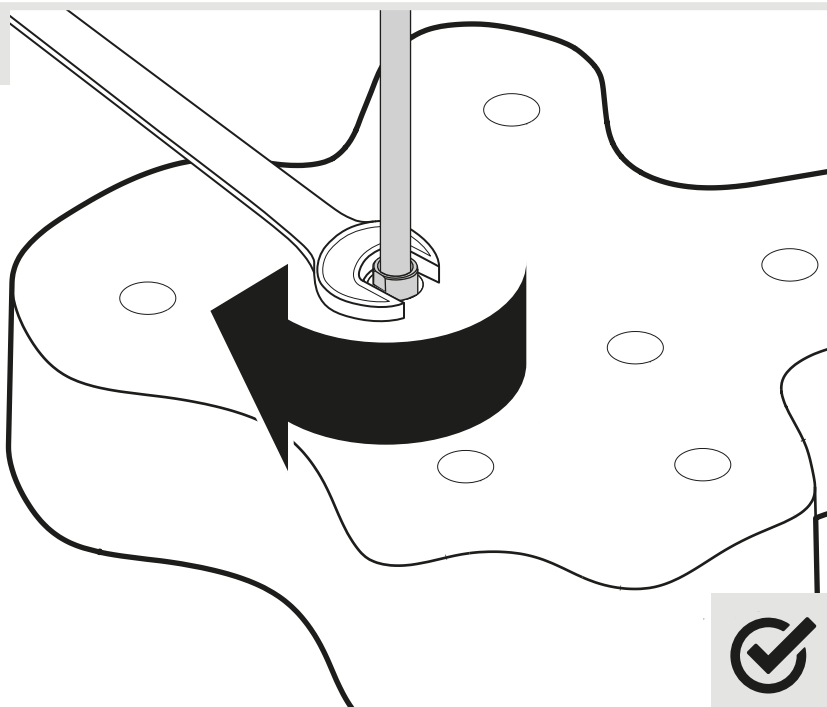

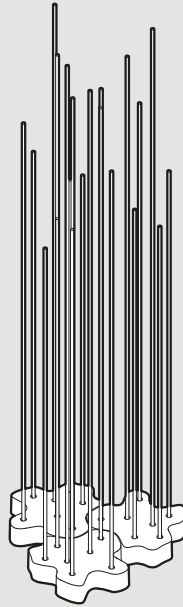

**i**



**1**





**Artemide®**

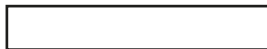

**Artemide**

via Bergamo, 18  
20010 Pregnana M.se (MI)  
ITALIA

tel. +39 02 935 181  
fax +39 02 935 90 254  
fax +39 02 935 90 496

[www.artemide.com](http://www.artemide.com)

VAT IT00846890150

cod. Y513000152F