

Artemide®

Megaron

design
G. Frattini

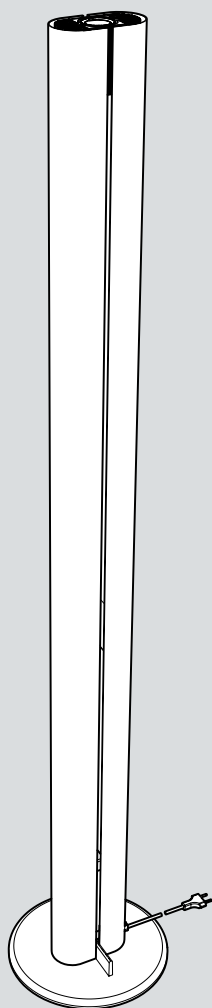



i

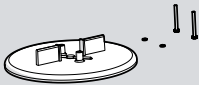
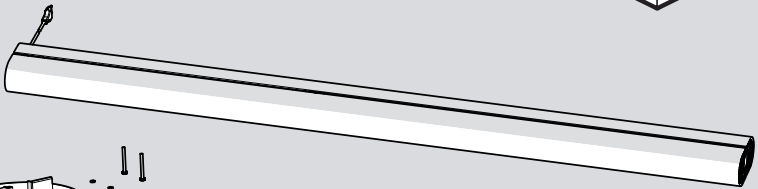
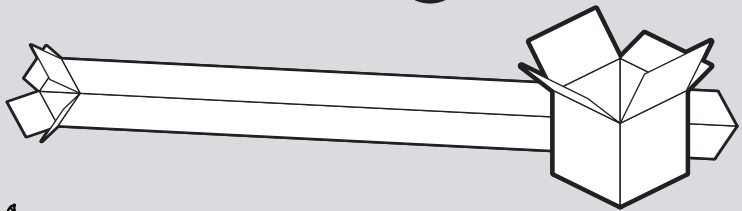
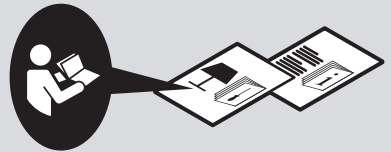
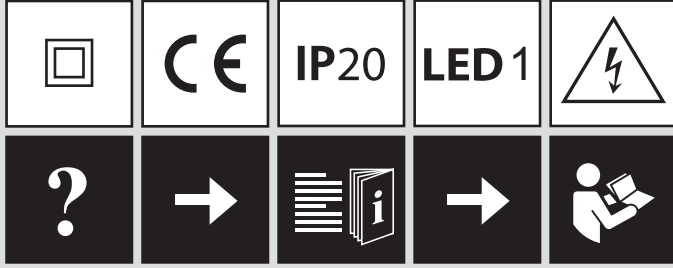

1

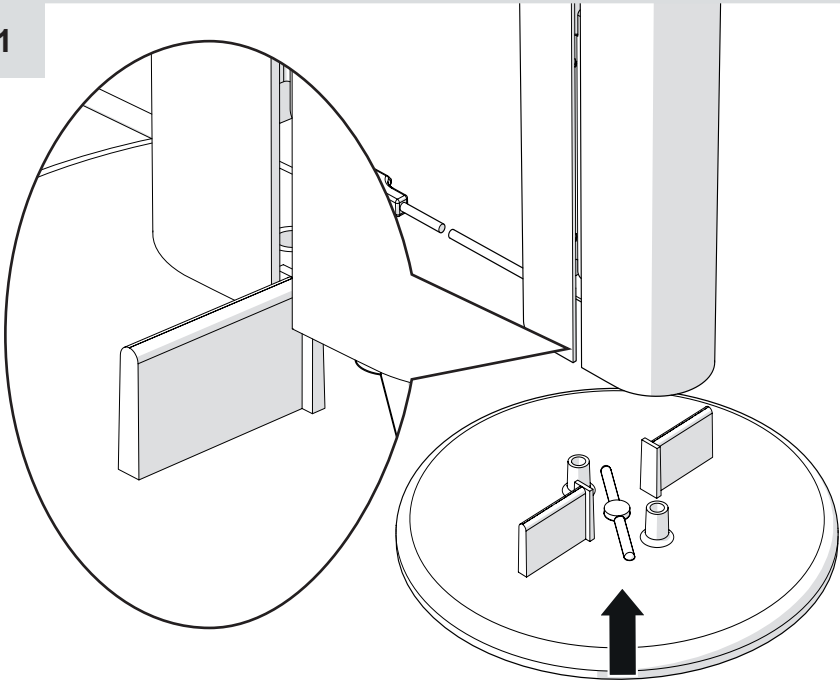

2

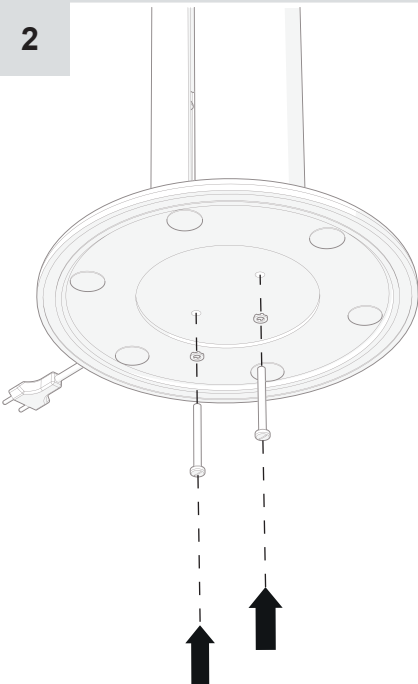

3

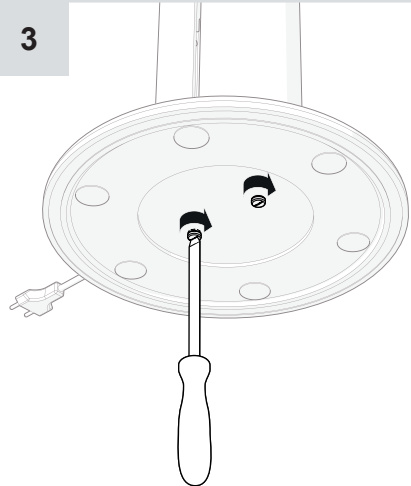

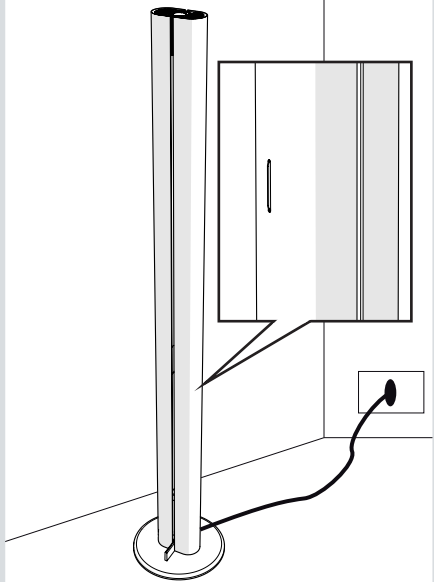
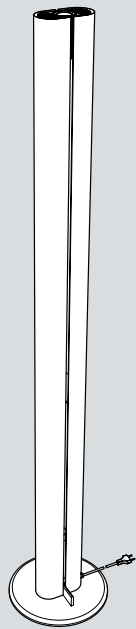

i

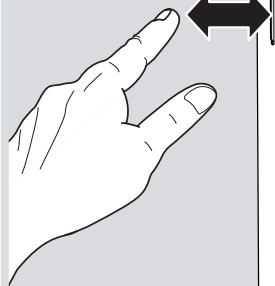
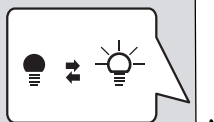

i

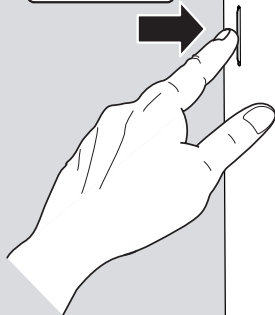
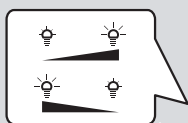

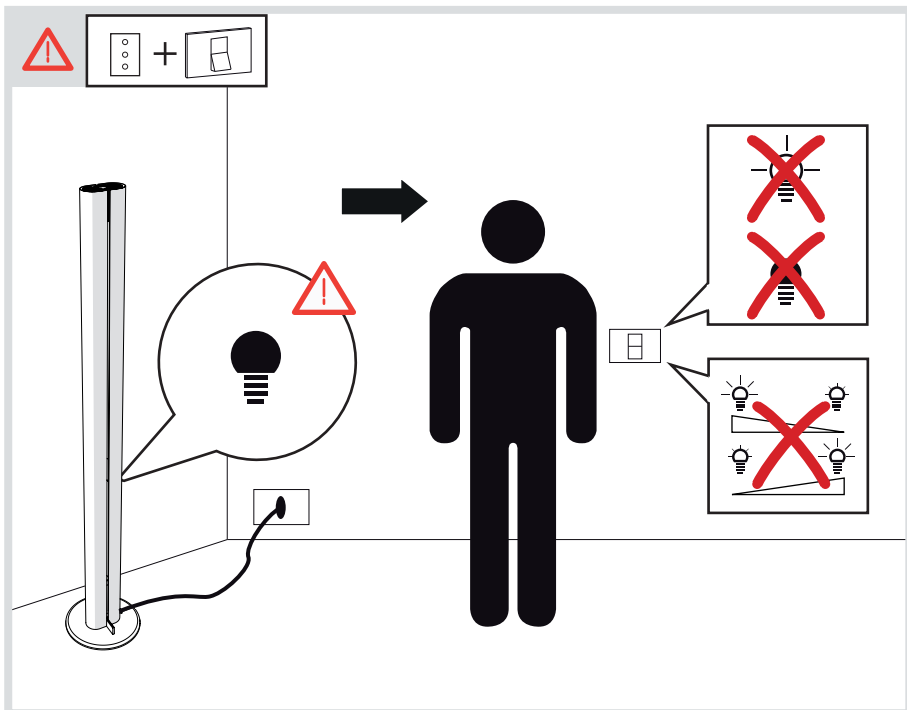
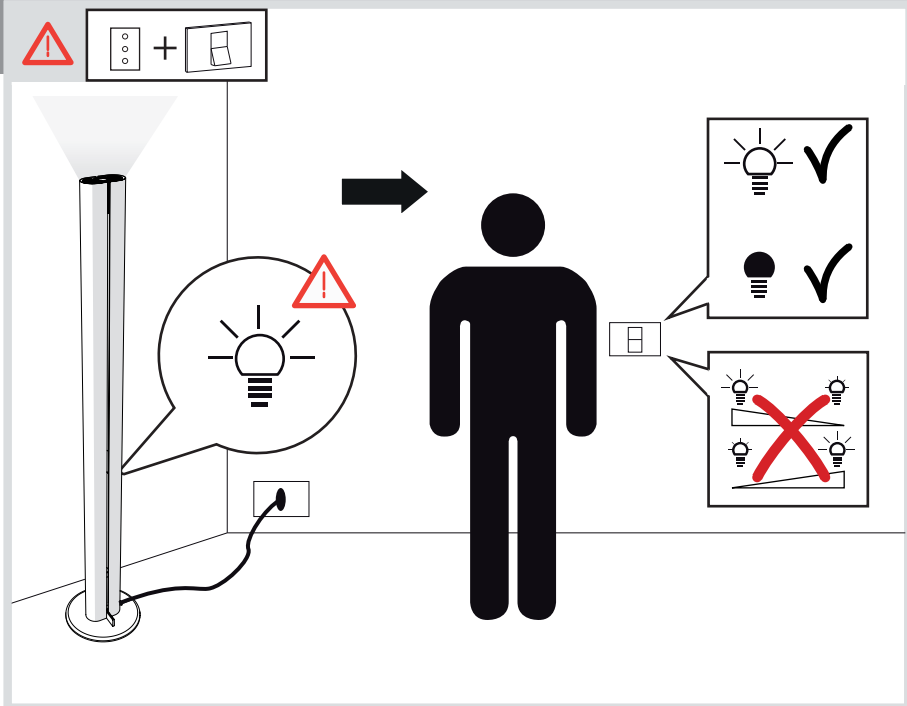



i



Artemide®



Artemide

via Bergamo, 18
20010 Pregnana M.se (MI)
ITALIA

tel. +39 02 935 181
fax +39 02 935 90 254
fax +39 02 935 90 496

www.artemide.com

VAT IT00846890150

cod. Y513000178A