

Artemide®

Pipe LED INTEGRALIS®

design
Herzog & De Meuron

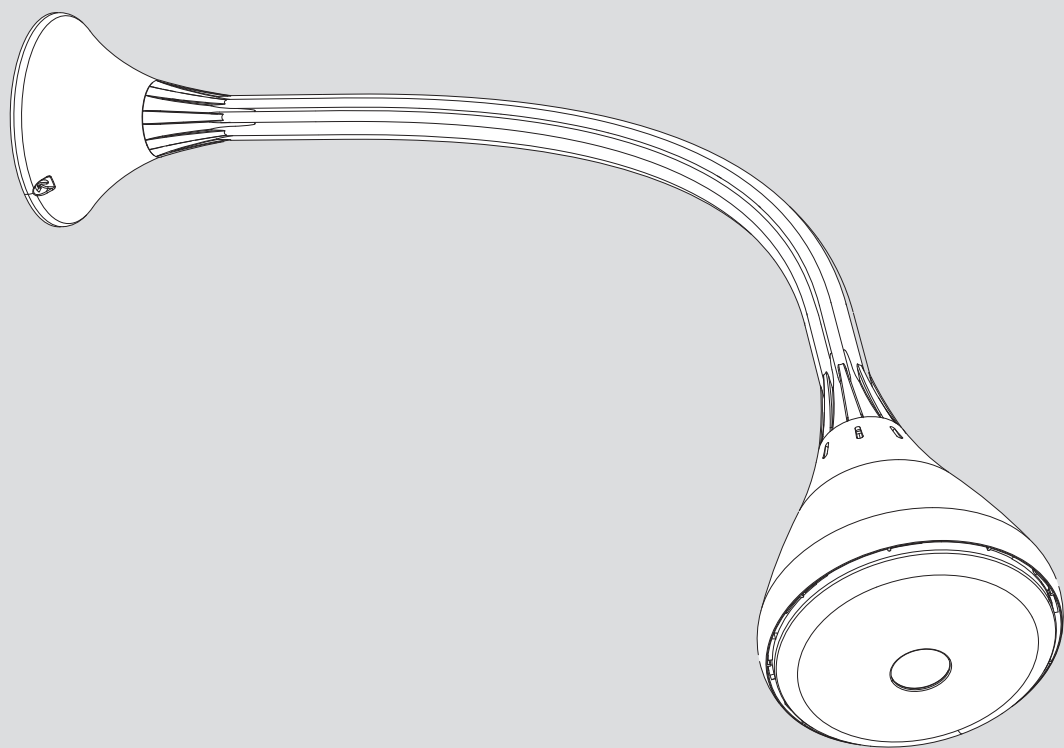



i



Artemide
INTEGRALIS

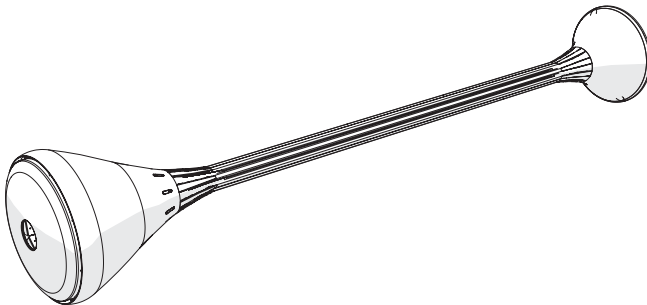
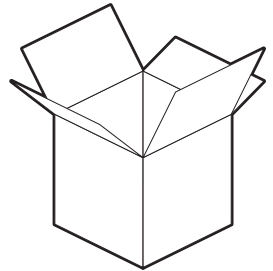
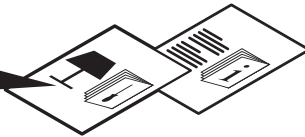

1



2

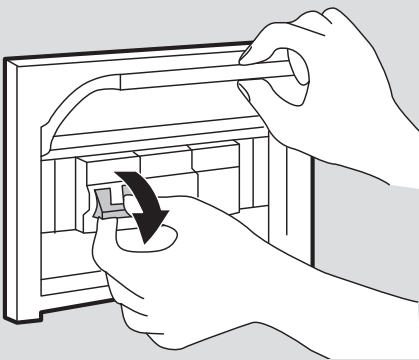
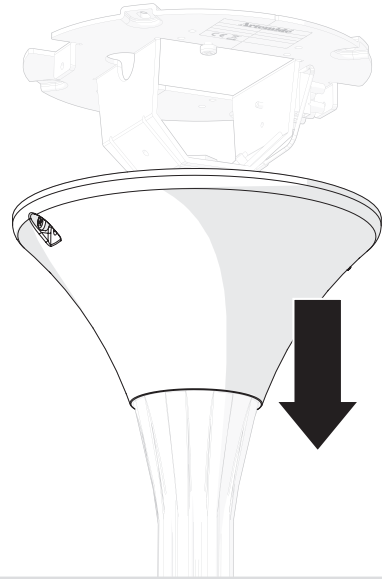

3

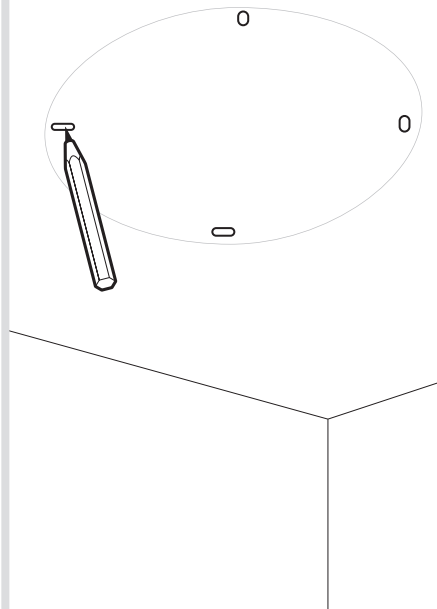

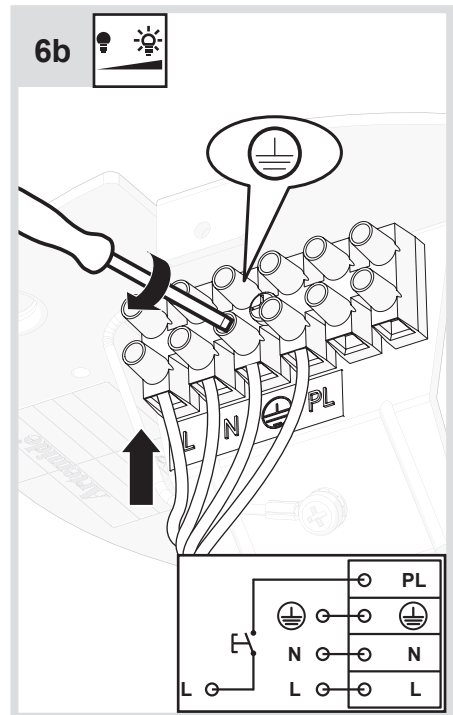
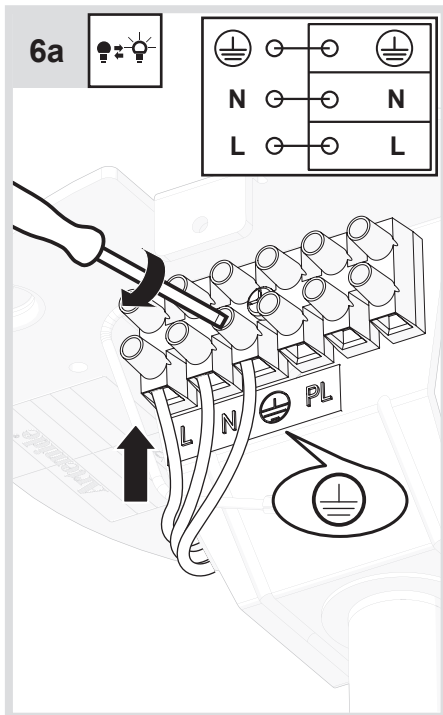
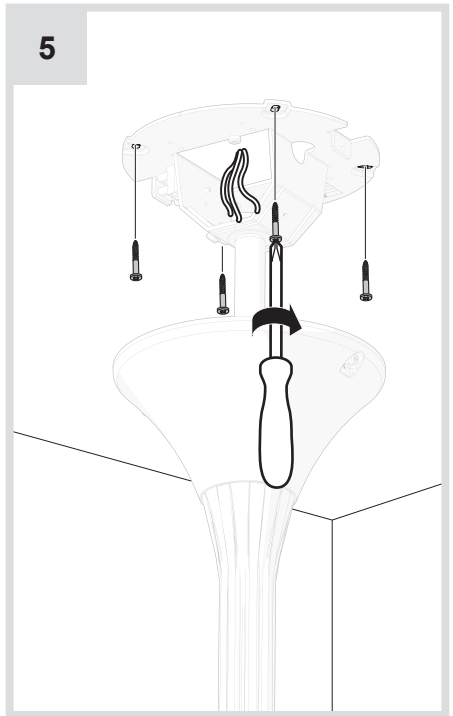
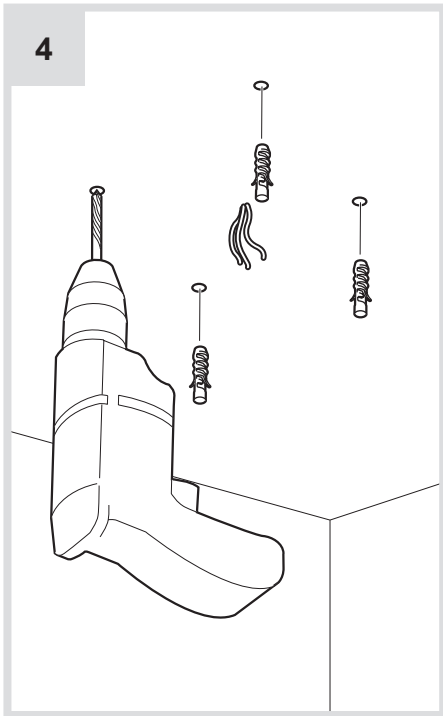

8

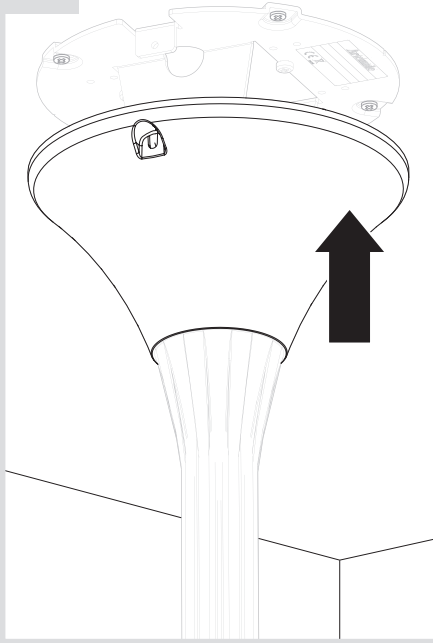

9

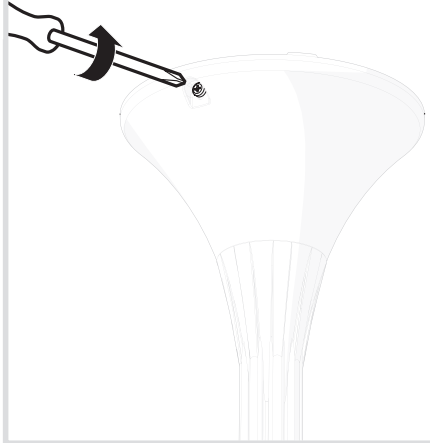

Artemide
INTEGRALIS

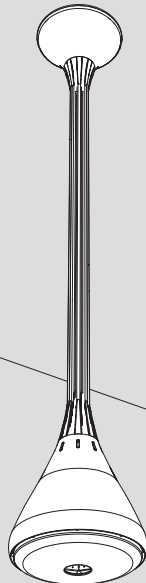



i

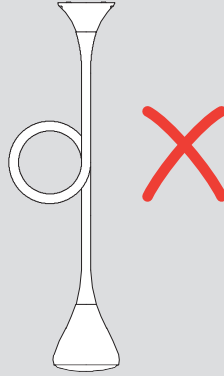
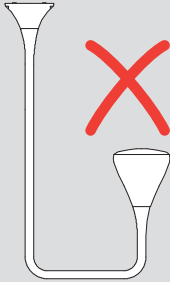
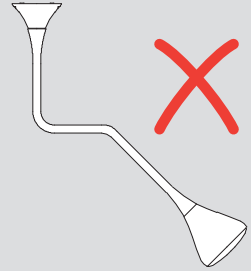
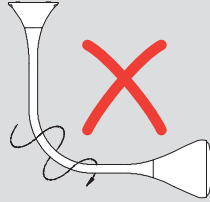
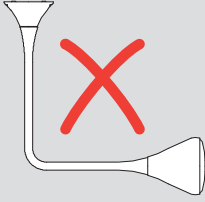

i

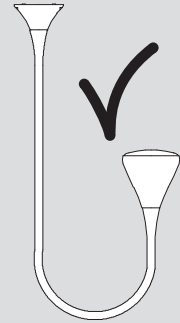
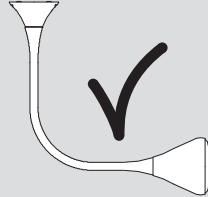
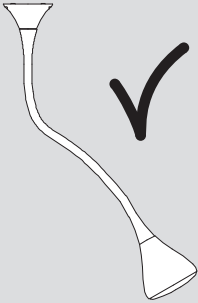

≥ 20 cm

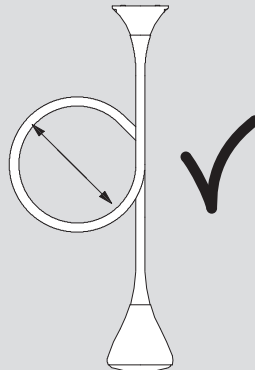



i

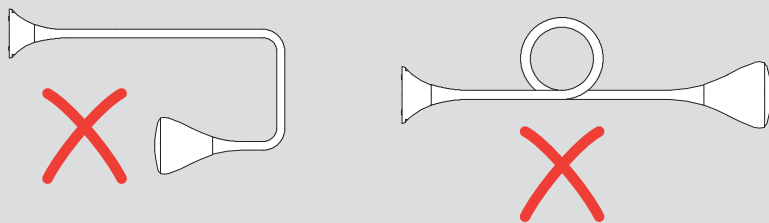

i

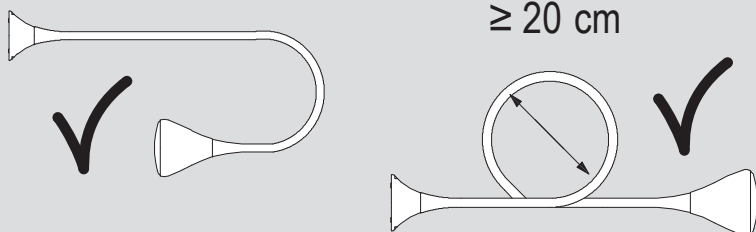
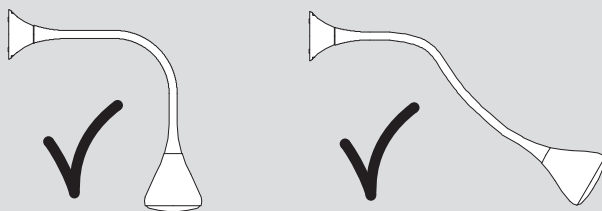

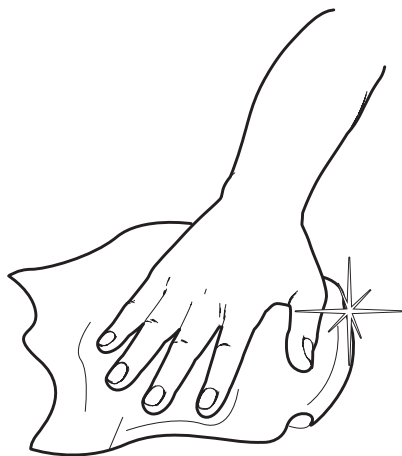

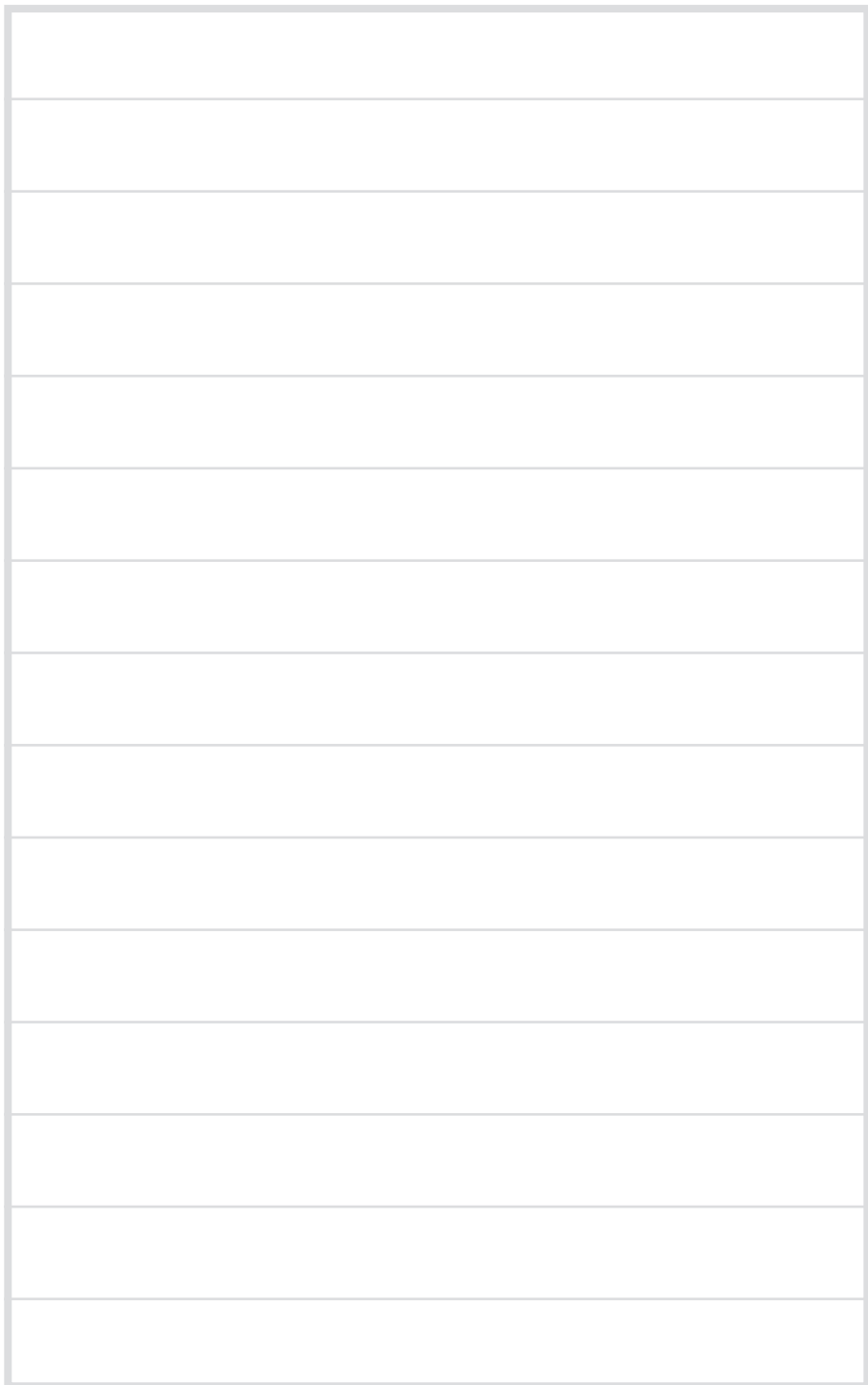

Artemide®

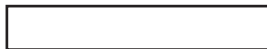

Artemide

via Bergamo, 18
20010 Pregnana M.se (MI)
ITALIA

tel. +39 02 935 181
fax +39 02 935 90 254
fax +39 02 935 90 496

www.artemide.com

VAT IT00846890150

cod. Y513001361A